

Single mode fiber achromatic collimator

1064nm (beam waist spot diameter 3.9mm

FCAPC)



- **Product Description**

Composed of a large numerical aperture lens system, it can use multimode optical fibers with larger numerical apertures. The beam emitted from the multimode fiber can be shaped, or the spatial plane beam can be coupled into the multimode fiber to achieve good collimation and spot shape over long distances.

● Product features

Achromatic design optimization; multimode fiber compatibility; enhanced thermal stability design; precise waist spot control; high power and reliability

● Part Number

MP-CLM-1064-3.9-0.026-SA

● Application area

Optical Network Testing | Industrial Sensing | Medical Endoscopy | Security Surveillance | Fiber Optic Component Inspection

● Core parameters

Center wavelength	Operating Bandwidth	Waist Beam	Connectors
1064nm	1050~ 1700nm	3.9mm	FC/APC

● General Parameters

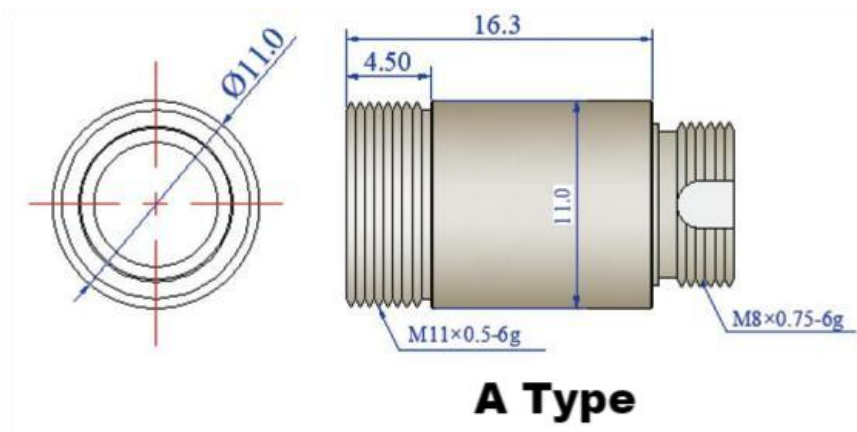

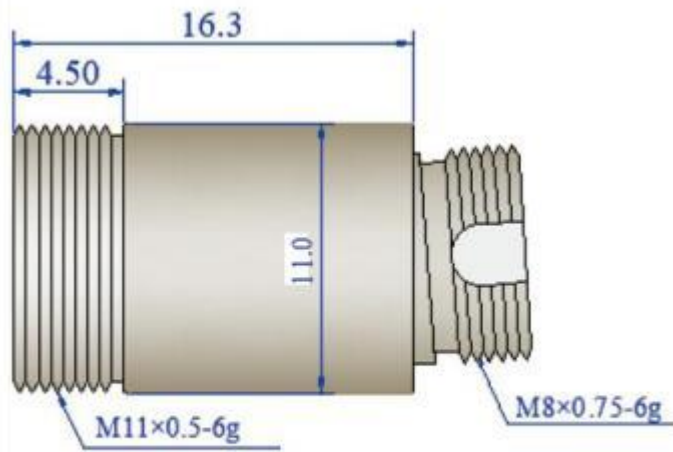

B Type

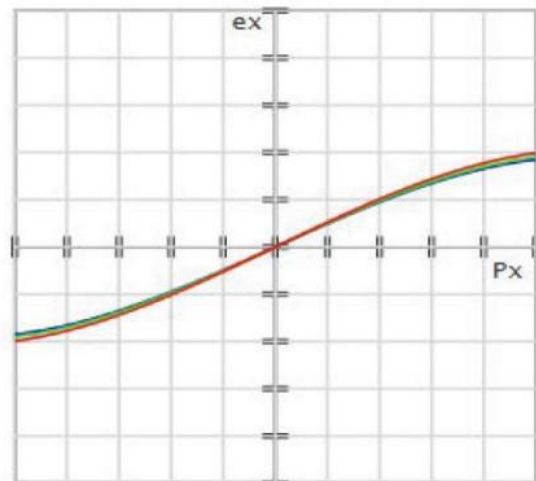
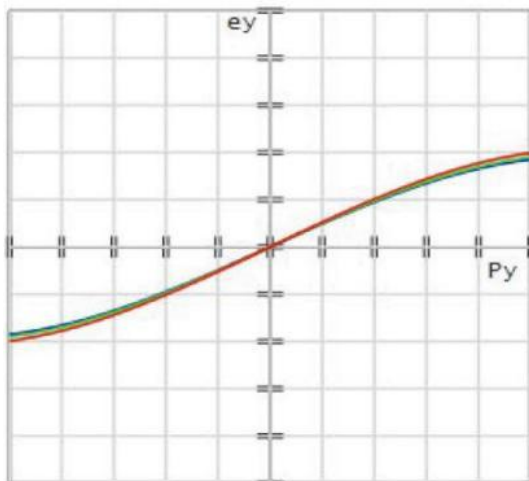
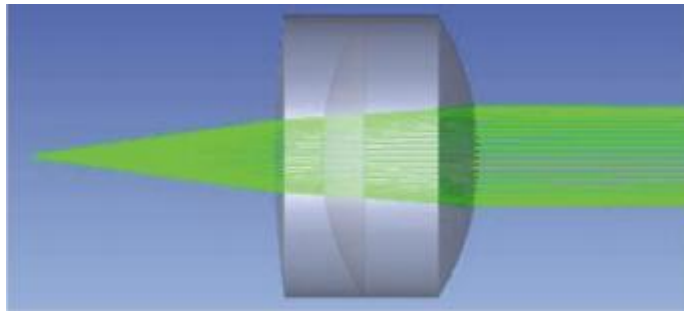

phasic variation curve with wavelength



Wavelength	Bandwidth	Waist Beam	Divergence Angle	EFL	NA	Package Dia.	Fiber Type	Max. Power	Transmittance
405nm	± 30nm	0.97 mm	0.062+ 0.01°	4.06 mm	0.61	Φ 11mm	405 HP	2W/mm ² @Beam Size	>95%
	± 30nm	2.0 mm	0.03+0 .01°	10.05 mm	0.37	Φ 11mm			
	± 30nm	3.7 mm	0.021+ 0.01°	15.96 mm	0.25	Φ 11mm			
	± 30nm	3.95 mm	0.015+ 0.01°	19.95 mm	0.2	Φ 11mm			
450nm	± 30nm	0.96 mm	0.06+0 .01°	4.10 mm	0.6	Φ 11mm	460		
	± 30nm	2.0 mm	0.028+ 0.01°	10.07 mm	0.37	Φ 11mm	HP		



	± 30nm	3.6 mm	0.020+ 0.01°	15.98 mm	0. 25	Φ 11m m		
	± 30nm	3.95 mm	0.014+ 0.01°	19.96 mm	0. 2	Φ 11m m		
520nm	± 30nm	0.92 mm	0.059+ 0.01°	4.15 mm	0. 6	Φ 11m m		
	± 30nm	2.0 mm	0.025+ 0.01°	10.09 mm	0. 37	Φ 11m m		
	± 30nm	3.2 mm	0.019+ 0.01°	15.98 mm	0. 25	Φ 11m m		
	± 30nm	3.95 mm	0.014+ 0.01°	19.97 mm	0. 2	Φ 11m m		
635nm	± 30nm	0.87 mm	0.056+ 0.01°	4.20 mm	0. 58	Φ 11m m	630 HP	
	±	2.0	0.024+	10.13	0.	Φ		

	30nm	mm	0.01°	mm	37	11m			
	±	3.12	0.019+	16.01	0.	Φ			
	30nm	mm	0.01°	mm	25	11m			
	±	3.95	0.014+	20m	0.	Φ			
	30nm	mm	0.01°	m	2	11m			
	±	1.95	0.031+	10.04	0.	Φ			
	30nm	mm	0.01°	mm	37	11m			
780nm	±	3.49	0.020+	16.0	0.	Φ			
	30nm	mm	0.01°	mm	24	11m			
	±	4.4	0.015+	20.03	0.	Φ	780		
	30nm	mm	0.01°	mm	2	11m	HP		
	±	2.0	0.030+	10.05	0.	Φ			
850nm	30nm	mm	0.01°	mm	37	11m			
	±	3.47	0.020+	16.01	0.	Φ			
	30nm	mm	0.01°	mm	24	11m			



						m			
	±	3.95	0.016+	20.03	0.	Φ			
	30nm	mm	0.01°	mm	2	11m			
						m			

Wavelength	Bandwidth	Waist Beam	Divergence Angle	EFL	NA	Package Dia.	Fiber Type	Max. Power	Transmittance
980nm	600~1050nm	2.0mm	0.035+ 0.01°	10.0 7mm	0.37	Φ 11mm	980HP	2W/mm ² @Beam Size	>95%
	600~1050nm	3.39mm	0.024+ 0.01°	16.0 3mm	0.24	Φ 11mm			
	600~1050nm	4.23mm	0.018+ 0.01°	20.0 5mm	0.2	Φ 11mm			
1064nm	1050~1700nm	2.0mm	0.038+ 0.01°	10.0 3mm	0.37	Φ 11mm	HI1060		



	1050~1 700nm	3.51 mm	0.032+ 0.01°	15.9 7mm	0. 24	Φ 11m m			
	1050~1 700nm	3.9 mm	0.026+ 0.01°	19.9 7mm	0. 2	Φ 11m m			
	1050~1 700nm	2.0 mm	0.053+ 0.01°	10.0 7mm	0. 37	Φ 11m m			
1310n m	1050~1 700nm	2.91 mm	0.036+ 0.01°	16.0 1mm	0. 24	Φ 11m m			
	1050~1 700nm	3.62 mm	0.028+ 0.01°	20.0 mm	0. 2	Φ 11m m	SMF		
	1050~1 700nm	2.0 mm	0.06+0 .01°	10.1 1mm	0. 37	Φ 11m m			
1550n m	1050~1 700nm	3.14 mm	0.039+ 0.01°	16.0 8mm	0. 24	Φ 11m m			
	1050~1	3.55	0.031+	20.0	0.	Φ			
							-28E		



	700nm	mm	0.01°	7mm	2	11m			
						m			
1654nm	1050~1	2.0	0.06+0	10.1	0.	Φ			
						11m			
	700nm	mm	.01°	4mm	37	m			
	1050~1	3.2	0.036+	16.1	0.	Φ			
							11m		
	700nm	mm	0.01°	5mm	24	m			
	1050~1	3.65	0.029+	20.1	0.	Φ			
						11m			
	700nm	mm	0.01°	2mm	2	m			

3D modeling drawing preview

