

1280nm 5W High-Power Broad-Area Laser

Diode

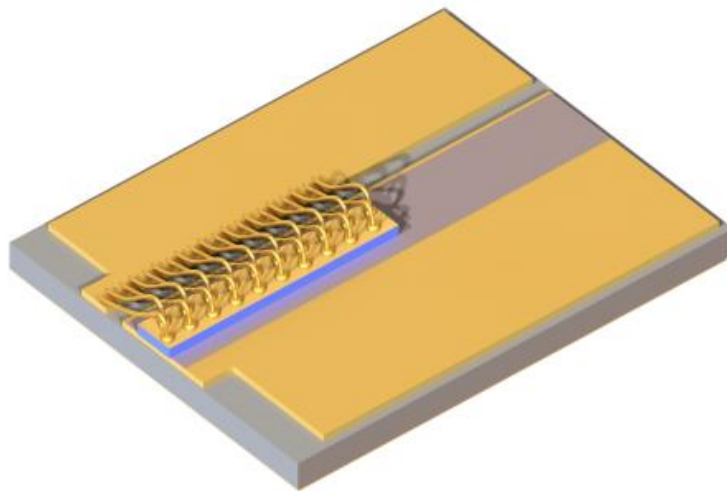

- **Product Description**

Proprietary mirror coating technology, high reliability, reliable Au/Sn bonding between the chip and composite submount, RoHS compliant.

- **Product features**

High power output; Broad emission area; Efficient heat dissipation; High electro-optical efficiency; Industrial-grade packaging

● Part Number

MP-BAL-1280-5W-Coc

● Application area

Fiber laser pumping | Industrial processing | Medical equipment | Defense applications | Scientific research experiments

● Core parameters

Output Power	Center Wavelength	Bandwidth	Stripe Width
5 W	1280 nm	10 nm	130 μ m

● Dimension Drawing

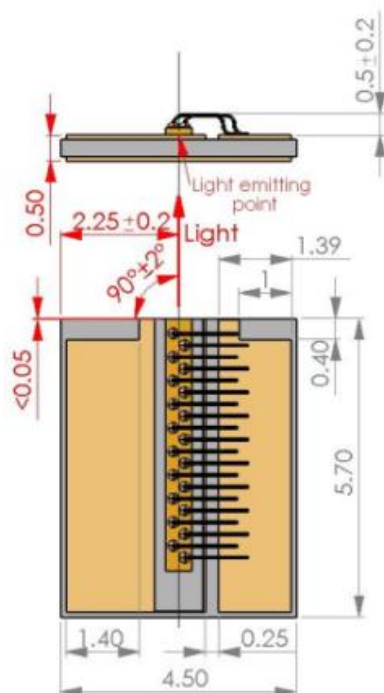

1. Tolerances not specified ± 0.5 nm
2. Red dimension refers to the emission point

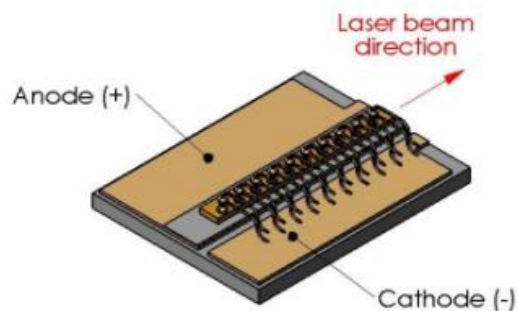

● General Parameters

Recommended Operating Conditions (Unit mounted on copper heat sink)

Parameter	Min. Value	Typ. Value	Max. Value	Unit
Heat Sink Temperature	20	25	30	°C
Forward Current	-	10	11.5	A
Output Power	0.5	-	5	W

**Characteristics(Tested for each sample under CW,
25°C, 20 A conditions)**

Parameter	Min. Value	Typ. Value	Max. Value	Unit
Forward Current @ 9 W	-	-	11.5	A
Forward Voltage	-	1.4	1.9	V
Threshold Current	-	0.7	1.1	A
Average Wavelength	1270	1280	1290	nm
Bandwidth (FWHM)	-	10	16	nm
Wavelength Tunability vs.	-	0.5	-	nm/°C



Temperature				
Slow-Axis Beam Divergence (FWHM)	4	7	12	deg
Fast-Axis Beam Divergence (FWHM)	-	30	36	deg
Stripe Width	-	130	-	μm
Polarization	-	TE	-	-

Absolute Maximum Ratings

Parameter	Min. Value	Max. Value	Unit
Output Power	-	7	W
Forward Current (CW)	-	13	A
Reverse Voltage	-	2	V
Soldering Temperature (max. 5 seconds)	-	250	°C
Operating Temperature (above dew point)	5	60	°C
Storage Temperature (above dew point)	-40	85	°C

Typical Performance

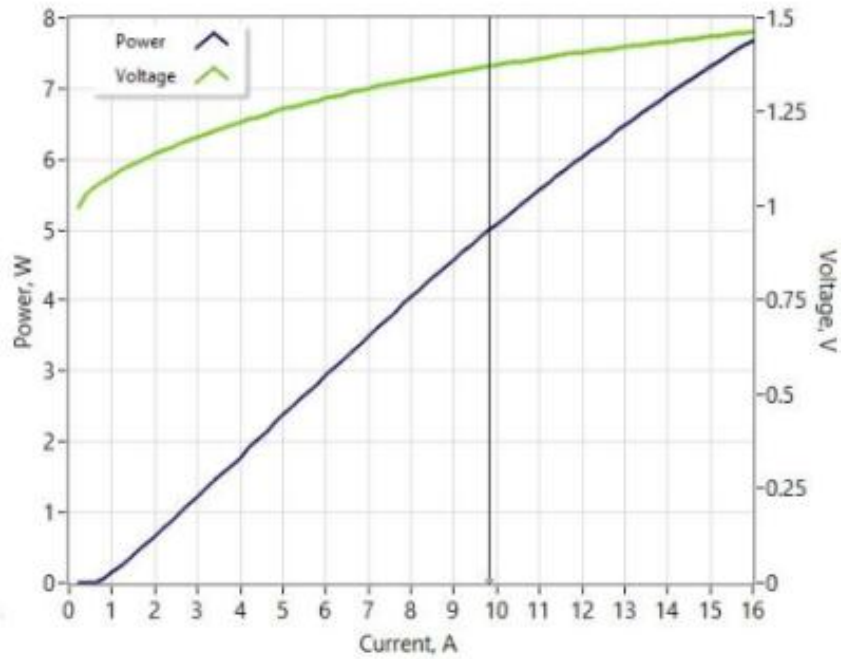

L-I-V characteristic graph

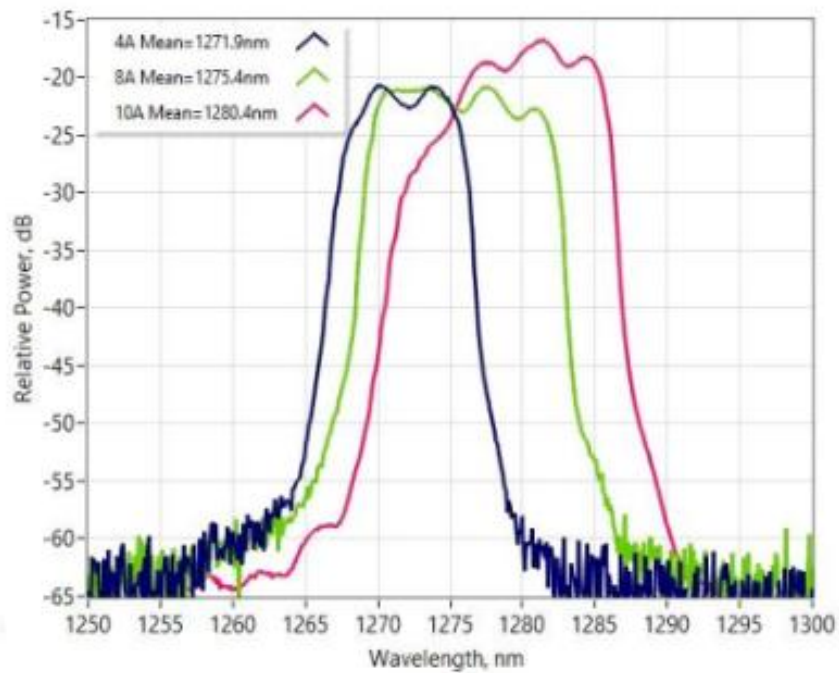

Optical Spectrum(Resolution 1nm)

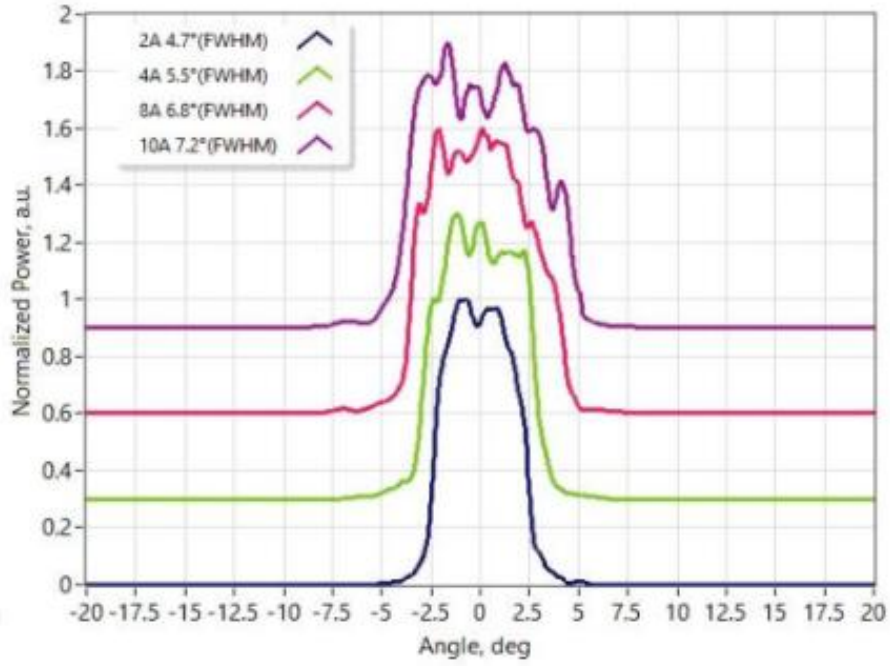

Slow-axis far-field

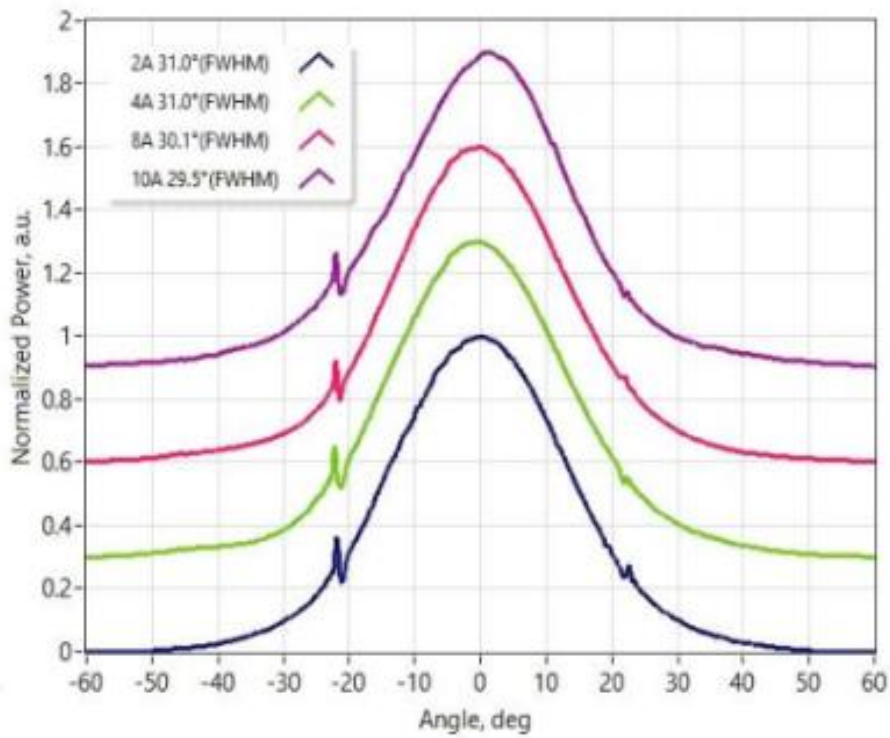

Far-axis far-field



Safety and Operating Instructions

The laser emitted by this device is invisible and harmful to the human eye. When the device is operating, avoid direct viewing of the fiber output or collimated beams along its optical axis. Always wear appropriate laser safety goggles during operation.

Absolute Maximum Ratings are only for short - term application to the device.

Long - term exposure to Maximum Ratings or exposure to one or more Maximum Ratings may cause device damage or affect device reliability.

Operation outside the product's Maximum Ratings may lead to device failure or safety hazards. Use the power supply matched with the device to ensure that the maximum peak optical power is not exceeded. Devices on the heat sink need appropriate heat dissipation; ensure the heat sink has sufficient heat dissipation and thermal conductivity. It is recommended to use indium foil (or similar materials) as the thermal interface between the C - type base and the heat sink surface.

This device is an open - heat - sink diode laser; it can only be operated in a cleanroom environment or a dust - proof housing. Must control the operating temperature and relative humidity to avoid condensation on the laser surface.

Avoid any contamination or contact with the laser surface.

ESD protection - Electrostatic discharge is the main cause of accidental product failure. Take extreme preventive measures to prevent ESD. When handling



products, use wrist straps, grounded work surfaces and strict anti - static technologies.

