

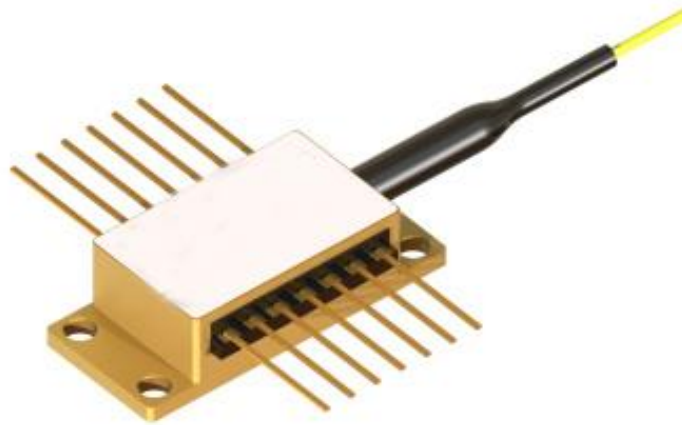

1064nm 400mW Fiber-Coupled Laser Diode



● Product Description

The fiber-coupled laser diodes from idealphotonics feature a compact structure, easy integration and high stability. They also reduce optical loss during long-distance transmission, maintain beam quality, and meet the requirements of high-demanding applications.

● Product features

High-efficiency fiber coupling; Multiple wavelengths available; Low-noise output; Compact and modular; Fast modulation



● Part Number

MP-FP-1064-400-14BF-XA

● Application area

Fiber Optic Sensing | Medical Equipment | Industrial Processing | Optical Communication | Scientific Research Experiments

● Core parameters

Central Wavelength	Peak Output Power (Pulsed)	Output Power
1064 nm	1000mW	400mw

● Dimension Drawing

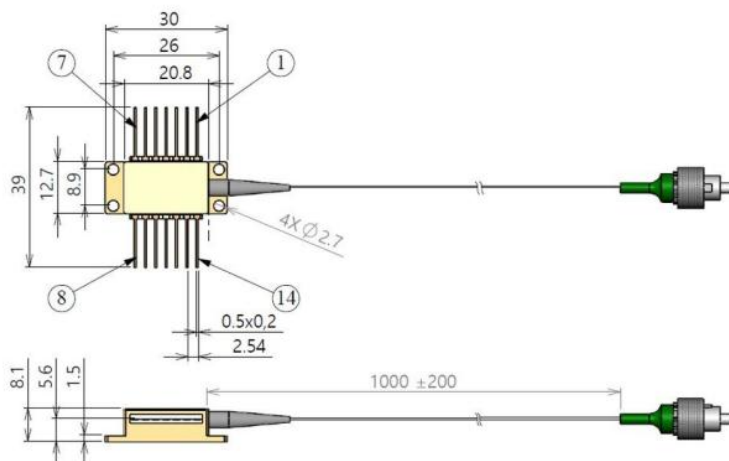

Pin identification:

1. TEC "+"
2. Thermistor
3. Monitor PD anode (Bias "-")
4. Monitor PD cathode (Bias "+")
5. Thermistor
6. -
7. -
8. -
9. -
10. LD anode ("+")
11. LD cathode ("-")
12. -
13. Case
14. TEC "-"



● General Parameters

Recommended Operating Conditions

Case mounted on a room temperature heat sink

Parameter	Min.	Typ.	Max.	Unit
Chip Temperature	20	25	30	°C
Forward Current @ CW Mode	—	2000	2300	mA
Peak Forward Current @ Pulse Mode	50	—	1000	mA
Output Peak Power @ Pulse Mode	—	800	1000	mW
Output Power @ CW Mode	20	—	400	mW

Pulse Characteristics (500 ns Pulse Width, 1% Duty Cycle)

25 °C, 2000 mA

Parameter	Min.	Typ.	Max.	Unit
Peak Forward Current @ 1000 mW	—	—	2300	mA
Average Wavelength	1059	1064	1069	nm
Spectral Width (FWHM), Resolution 200 pm	1	2.7	6	nm

CW Characteristics

@ 25 °C*, 800 mA

Parameter	Min.	Typ.	Max.	Unit
Forward Current @ 400 mW	—	—	1000	mA
Forward Voltage	—	1.7	2.2	V
Threshold Current	—	80	160	mA
Average Wavelength	1058	1064	1070	nm
Spectral Width (FWHM), Resolution 200 pm	—	1	5	nm
Wavelength Temperature Tuning	—	0.35	—	nm/°C
Polarization Extinction Ratio (PER)	15	19	—	dB
Polarization	—	TE	—	—

Typical Performance

Test condition: 500ns pulse width, 1% duty cycle

L-I-V characteristic graph

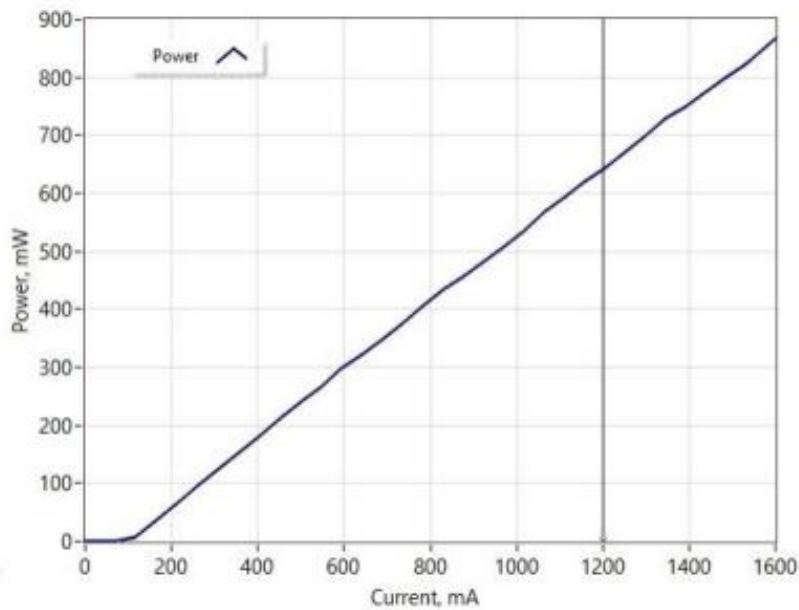

Optical Spectrum (Resolution 200pm)

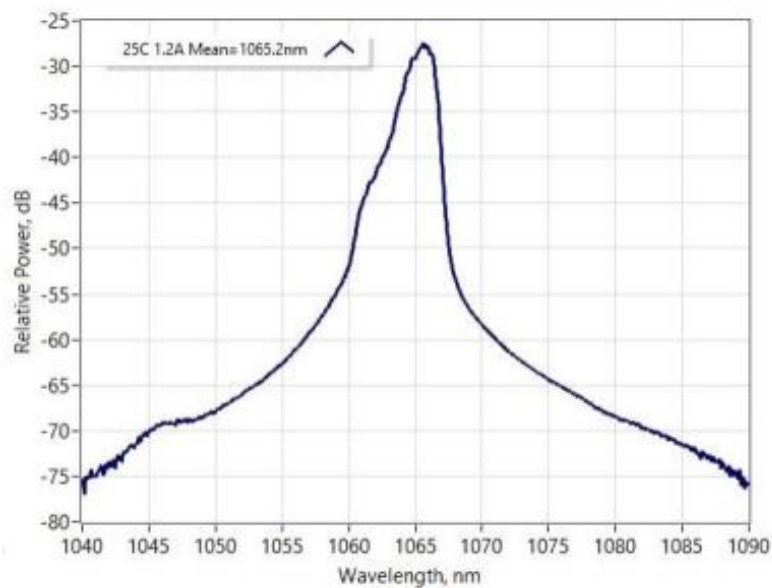

Pulse shape

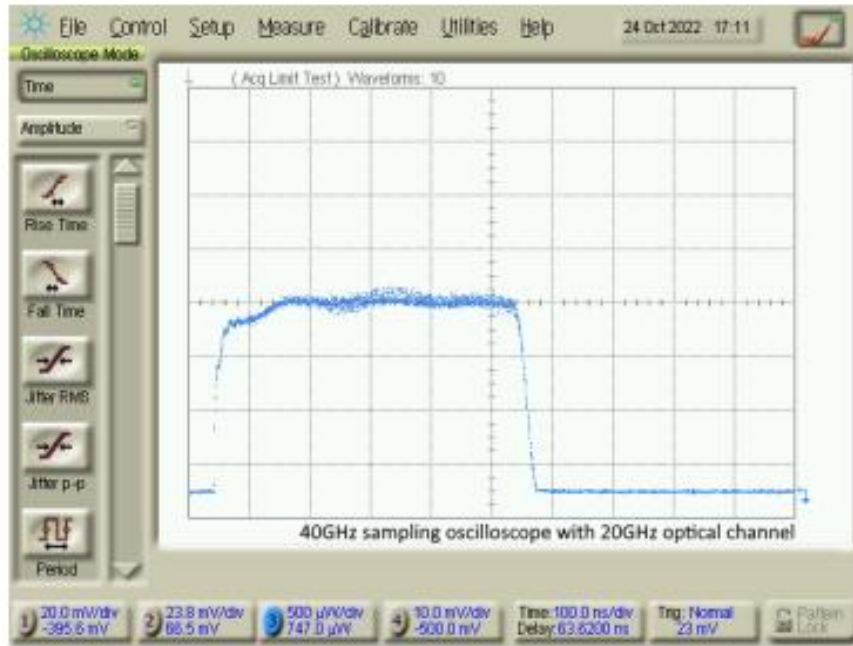

Typical CW Performance

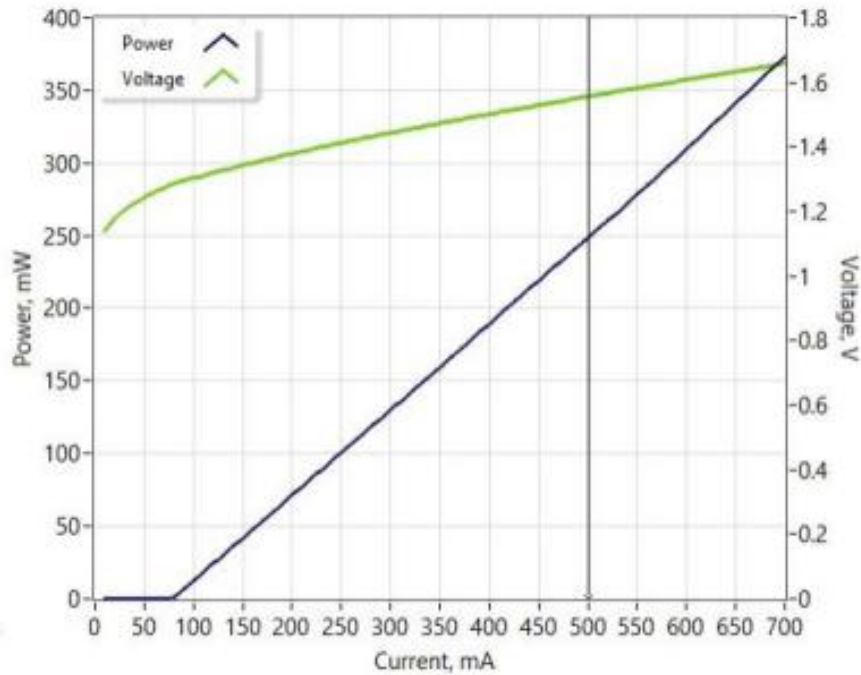

Optical Spectrum (Resolution 200pm)

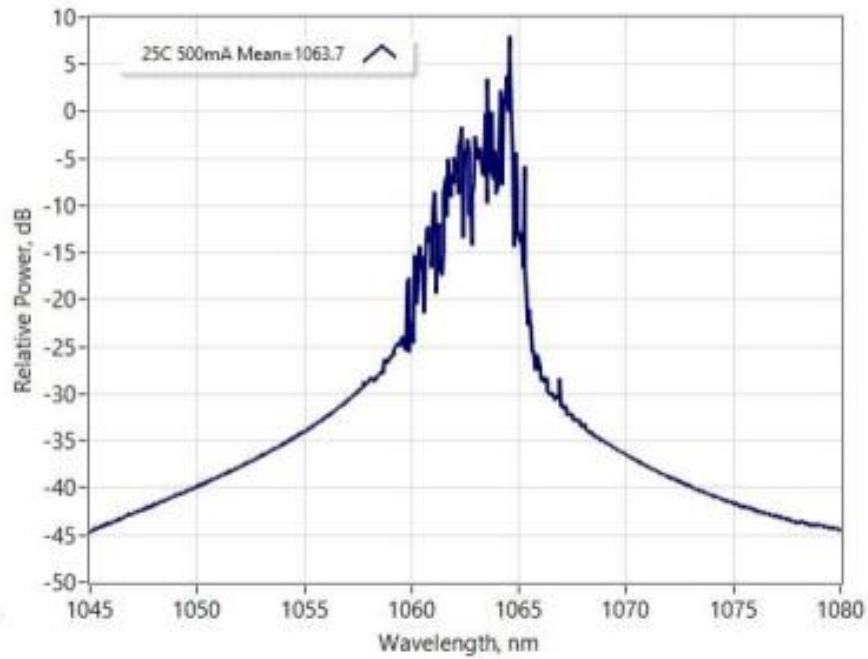

Max. Rating Parameters

Parameter	Min.	Max.	Unit
Output Peak Power in Pulse Mode (<1 ns Pulse Width, <10% Duty Cycle)	—	1400	mW
Peak Forward Current in Pulse Mode (<1 ns Pulse Width, <10% Duty Cycle)	—	2600	mA
Output Power in CW Mode	—	650	mW
Forward Current in CW Mode	—	1200	mA



Reverse Voltage	—	2	V
TEC Current	—	3	A
TEC Voltage	—	4	V
Chip Operating Temperature	5	40	°C
Case Operating Temperature	0	70	°C
Storage Temperature	-40	85	°C
Pin Soldering Temperature (Max. 10 s, Case Temp. ≤ 120 °C)	—	300	°C
Fiber Bend Radius	3	—	cm

General Parameters

Thermistor Specifications			Fiber Specifications			
Parameter	Value	Unit	Parameter	PM980	HI1060	Unit
Thermistor Type	NTC	—	Numerical Aperture, typical	0.12	0.14	—
Resistance @ 25 °C	10 ± 0.1	kΩ	Cutoff Wavelength	900 ± 70	920 ± 50	Nm

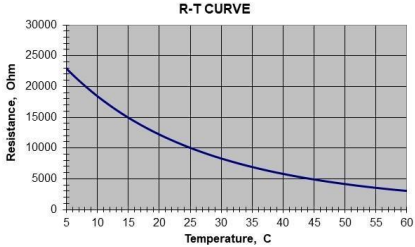
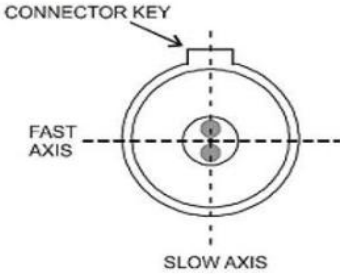

Beta (25–85 °C)	3435 ± 1%	K	Mode Field Diameter (@ 1060 nm)	6.6 ± 0.3	6.2 ± 0.3	µm	
			Cladding Diameter	125±1	125±1	µm	
			Coating Diameter	245±15	245±15	µm	
			Loose Tube Diameter (Optional)	900	900	µm	
			Connector	FC/APC (narrow key)			
			Connector Alignment aligned with PANDA fiber				
 <p>Output light is polarized along the slow axis of the PM fiber.</p>							

Safety and Operating Instructions

The light emitted by this device is invisible and harmful to human eyes. Avoid direct eye exposure to the fiber connector while the device is in operation. Proper laser safety goggles must be worn when operating with the connector open.

Absolute maximum ratings should only be applied to the device for short periods. Prolonged exposure to maximum ratings or exposure to multiple maximum ratings simultaneously may damage the device or impair its reliability. Operation beyond the absolute maximum ratings may result in device failure or safety hazards. A power supply suitable for the assembly must be used to ensure the maximum forward current is not exceeded.

Devices mounted on a heat radiator require an appropriate heat sink. The device must be installed on the heat sink using 4 screws (cross-tightened with an initial torque of 0.075 Nm and a final torque of 0.15 Nm) or a clamping mechanism. The flatness deviation of the heat sink surface must be less than 0.05 mm. The use of indium foil or a soft thermally conductive material as a thermal interface between the bottom of the package and the heat sink is recommended. Thermal grease is not suitable for this purpose.

Avoid back-reflection to the device. It may degrade the device performance in terms of spectral and power stability. It may also cause catastrophic facet



damage. The use of an optical isolator to suppress back-reflection is strongly recommended.

Do not pull the fiber. Do not bend the fiber with a radius smaller than 3 cm. The fiber tip shall be protected against contamination or damage at all times during installation. After removing the dust cap from the fiber tip, carefully clean it by wiping in one direction with optical lens cleaning paper or a cotton swab moistened with isopropyl alcohol or ethanol. Operate the device only with clean fiber connectors.

ESD Protection – Electrostatic discharge is a major cause of unexpected product failure. Extreme caution shall be taken to prevent ESD. ESD protection must be maintained during device installation – use wrist straps, grounded work surfaces, and strict anti-static techniques when handling the product.

