

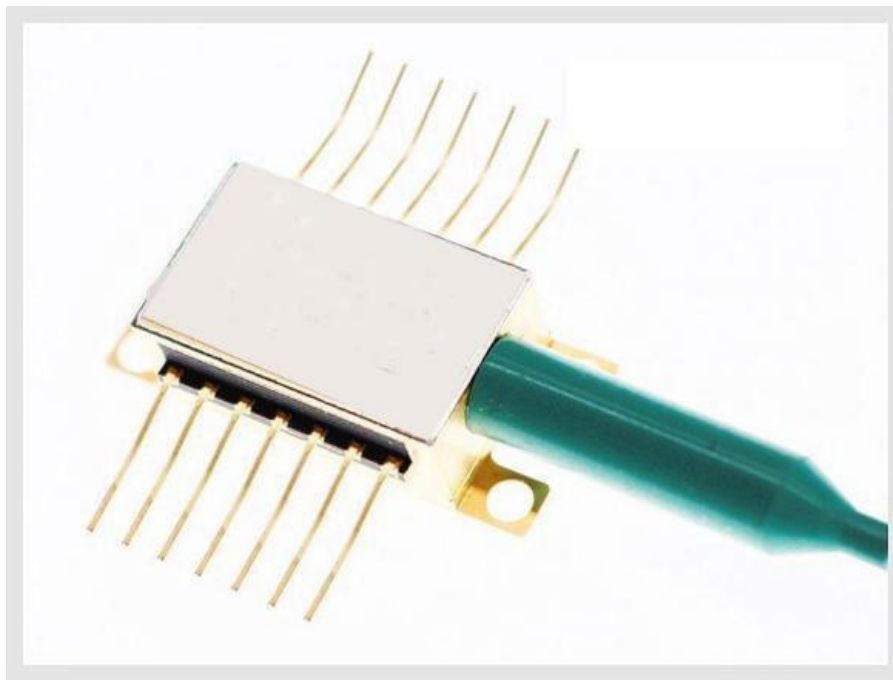

1540-1560nm 40mW SM 8nm Tunable DBR

Laser Diode



● Product Description

This single-frequency DBR laser diode is ideal for applications including low-noise pumping, second harmonic generation, time-resolved fluorescence spectroscopy, and fiber-optic sensing. The laser is integrated with an optical isolator, thermoelectric cooler (TEC), thermistor, and monitoring photodiode. It is housed in a 14-pin butterfly package, equipped with an SMF-28E single-mode fiber and FC/APC connector.



- **Product features**

8nm tunable bandwidth; High side-mode suppression ratio (SMSR) ; Low power consumption; High wavelength stability; Fast wavelength switching capability

- **Part Number**

MP-DBR-1550-40-14BF-SA

- **Application area**

Dense Wavelength Division Multiplexing (DWDM) | Fiber-optic Sensing | Quantum Key Distribution (QKD) | LiDAR | Scientific Spectroscopy Experiments

- **Core parameters**

Center Wavelength	Spectral Linewidth
1550nm	3MHz

● Dimension Drawing

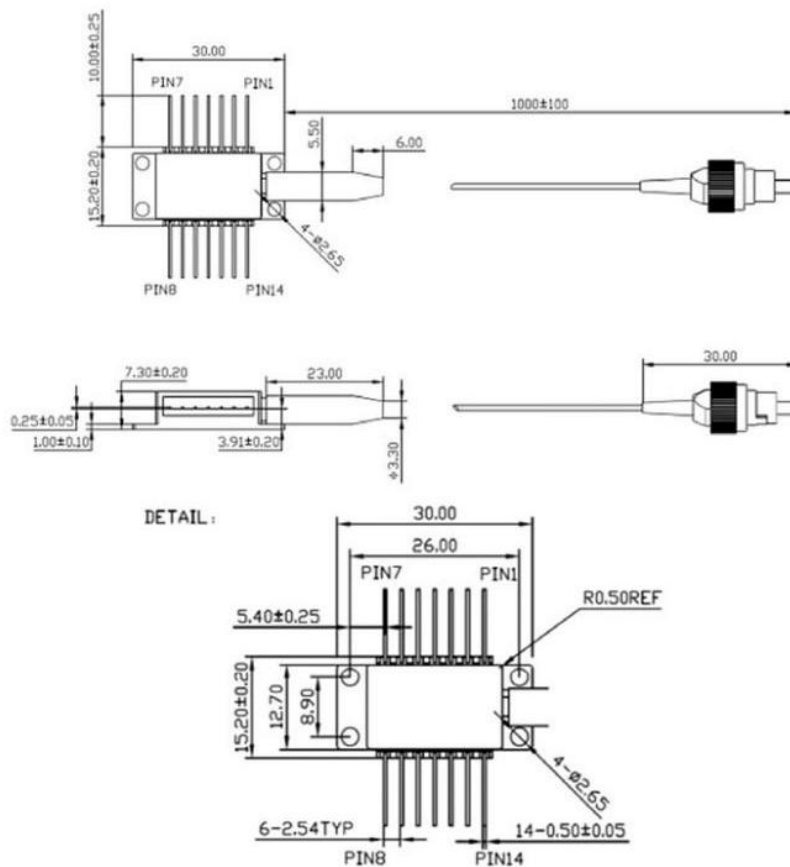

● General Parameters

Detailed parameters

Parameters

Laser characteristics (continuous wave mode, temperature = 25°C)

• Parameters	Minimum	Standard	Max	unit
Optical output power * a	30	40	-	mW
Center wavelength (customizable)		1550		nm
Wavelength tuning range	6	8		nm
Wavelength tuning rate	-	-	10	ms



Spectral width	-	3	--	MHz
RF direct modulation rate	-	10	-	Gb/s
Threshold current	-	40	-	mA
Polarization extinction ratio	20	-	-	dB
Edge mode suppression ratio	40	50	-	dB
Relative intensity noise	-	-	-135	dB/Hz
Chip temperature	10	25	40	°C
Operating temperature	-5	-	+75	°C
Storage temperature	-40	-	+85	°C

A. Test the drive current @250mA

B. Test drive current @150mA, self-heterodyne delay fiber @25km

Absolute maximum rating

Laser section	Current operating range Continuous wave (C.W.) range (mA)	Absolute maximum rating	
		Current (mA)	Voltage (V)
gain	100-250	350	2.0
Rear grating	0-90	120	2.0
Phase tuning	0-5	10	2.0

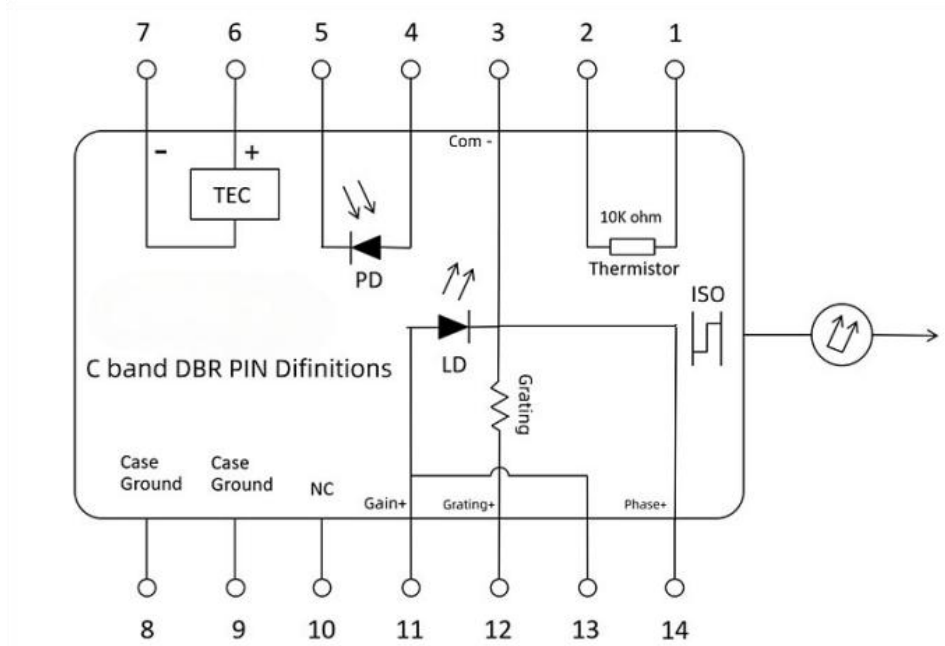

Pin definition

Stitches	Function	Stitches	Function
1	Thermistors	8	Case ground
2	Thermistors	9	Case ground
3	Laser Diode Cathode (-)	10	NC (No Connection)
4	Monitor photodiode anode	11	gain
5	Monitor photodiode cathodes	12	Grating
6	Thermoelectric cooler positive (+)	13	gain
7	Thermoelectric cooler negative electrode (-)	14	Phase

Characteristic curves

Tuning characteristic curve (tuning range 8.5-10 nm).

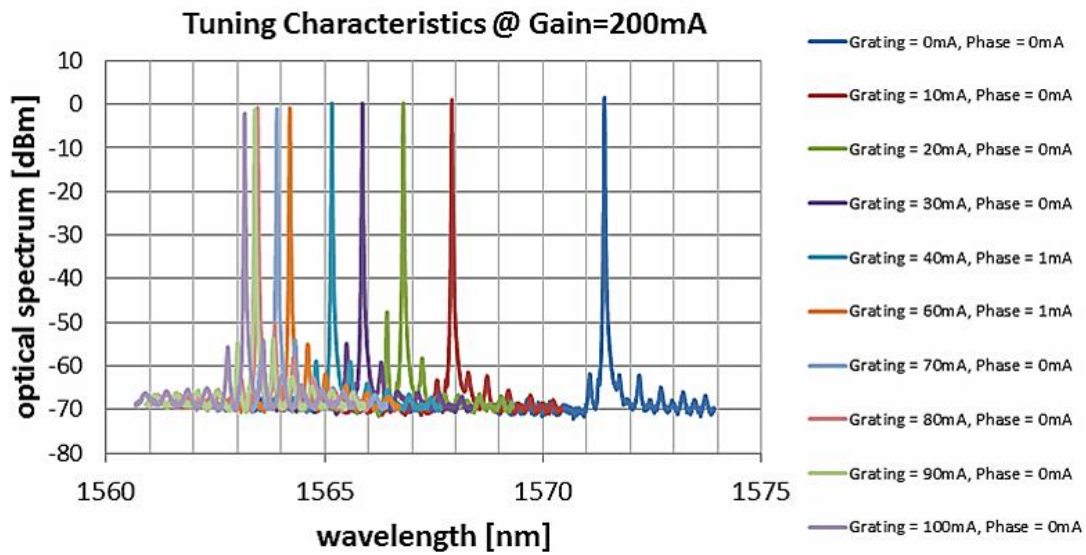
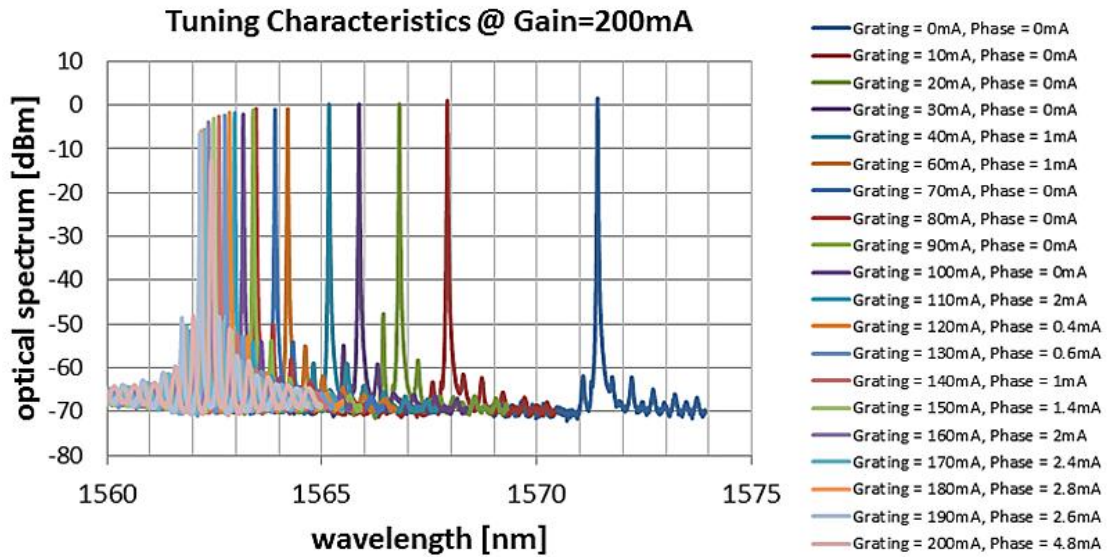

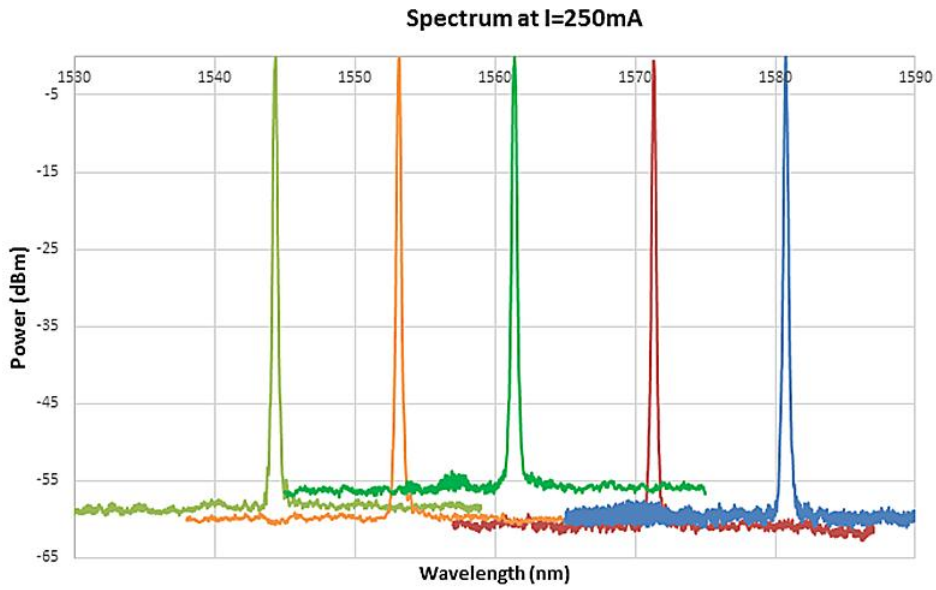

Optical power - current - voltage

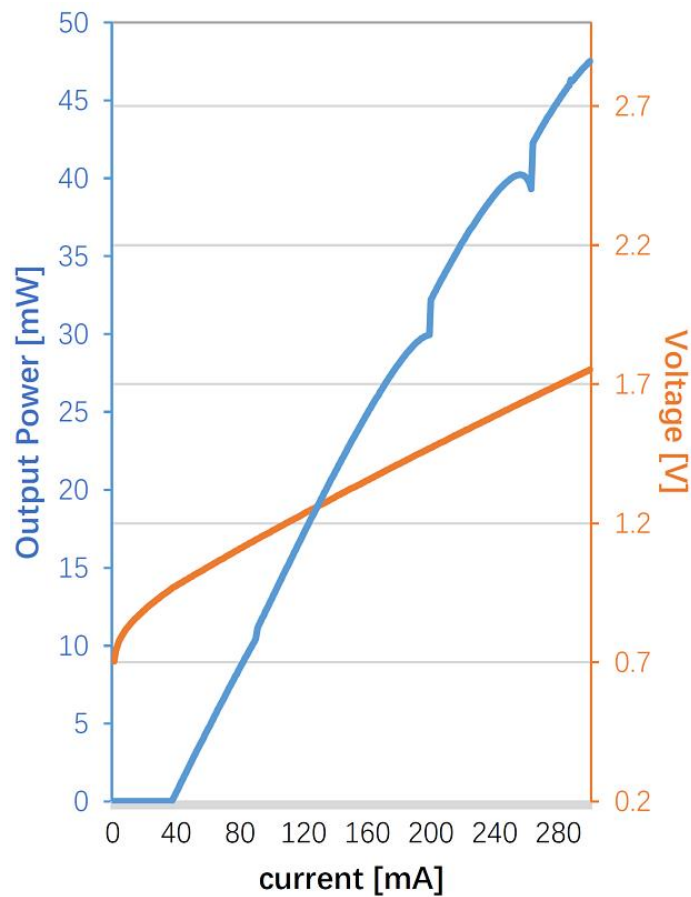

1550nm Distributed Bragg Reflection (DBR) Laser Tuning Characteristics

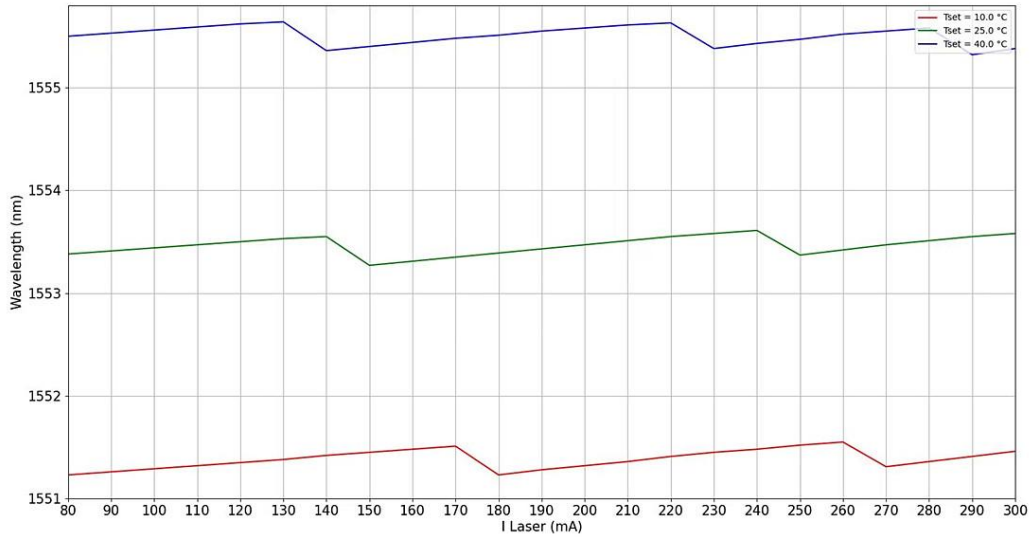

Distributed Bragg Reflection (DBR) laser line width test results

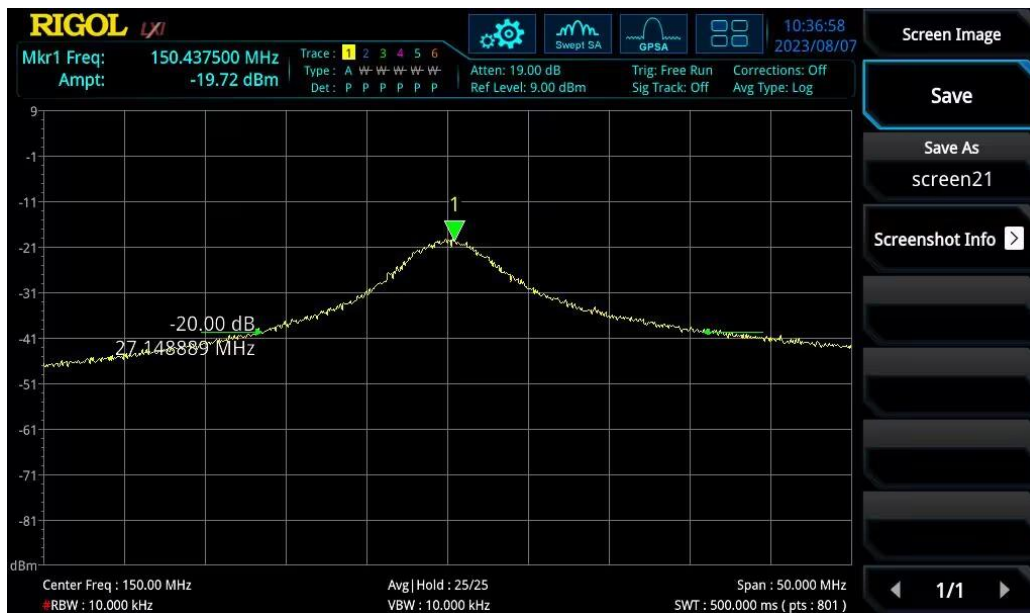



Grating Tuning Current (Wavelength Direction)

1550nm DBR Wavelength Tuning Range@25°C

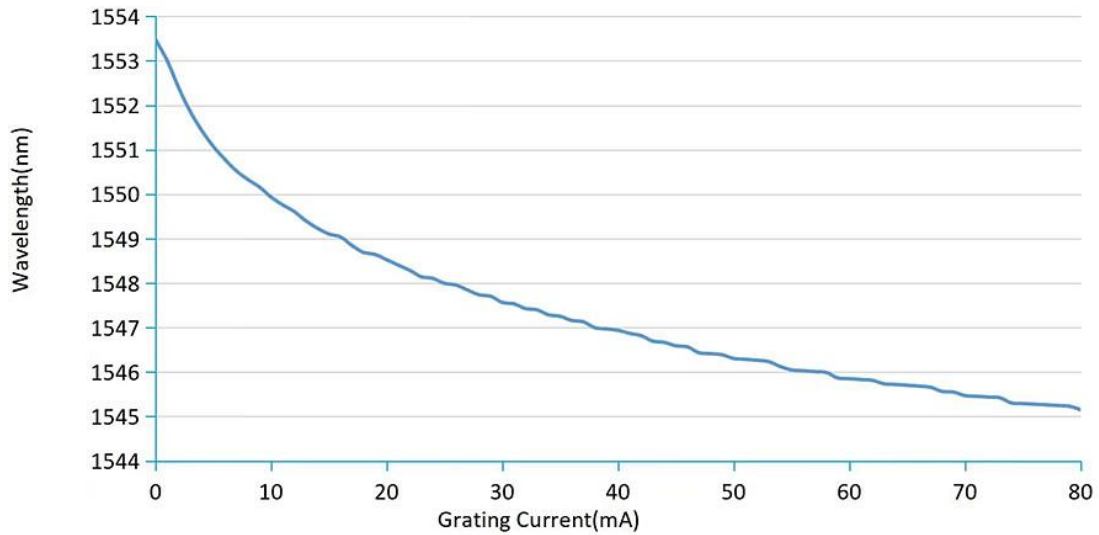

Ordering information

Purchase information

MP-DBR-□□□□-☆-▽-XX

□□□□:Wavelength

1540:1540nm

1560:1560nm

☆:Output Power

30:30mW

50:50mW

▽:Wavelength Tolerance



1:±1nm

2:±2nm

XX:Fiber and Connector Type

SA=SMF-28E+ FC/APC

SP=SMF-28E+ FC/PC

PP=PM Fiber+ FC/PC

PA=PM Fiber+ FC/APC