

1020nm Broadband Semiconductor Optical Amplifier

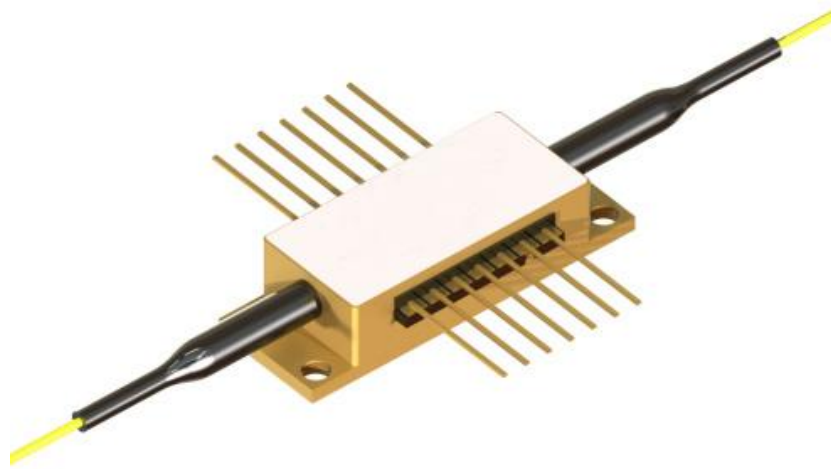

● Product Description

A high-performance broadband semiconductor optical amplifier designed specifically for the 1020nm near-infrared band. Based on the InAs/GaAs quantum dot material system, the chip end face adopts a tilted waveguide design and an anti reflection coating (reflectivity<0.001%), which can effectively suppress Fabry Perot oscillation and ensure stable operation of the device in amplification mode. The product provides an ultra wide gain bandwidth of up to 110nm and a small signal gain of up to 30dB, covering the key wavelength range of 970-1080nm. It is widely used in fields such as



swept frequency light sources, optical coherence tomography (OCT), fiber optic sensing, and tunable lasers

● Product features

Wide gain bandwidth; high output power; low noise; broad wavelength coverage; compact design

● Part Number

MP-SOA-1020-30db-110-XA

● Application area

Fiber Communication | Spectral Analysis | Optical Testing | National Defense
Sensing | Data Center

● Core parameters

Operating Wavelength	Operating Bandwidth
1020nm	110nm



● Dimension Drawing

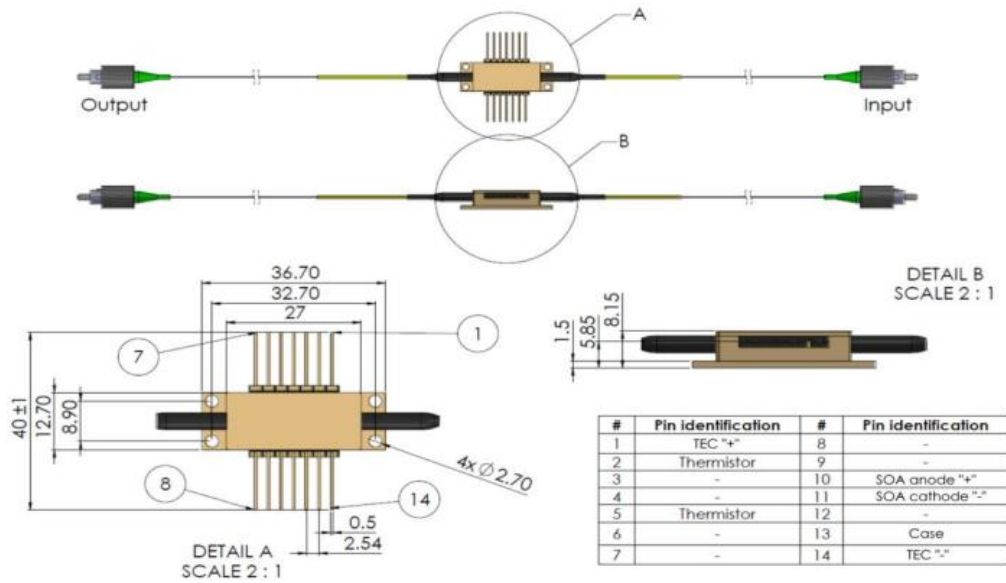

● General Parameters

Detailed Specifications

Recommended Operating Conditions

@ CW, housing mounted on a heat sink at room temperature

Parameter	Min.	Typ.	Max.	Unit
Chip Temperature	20	25	30	°C
Forward Current	—	550*	600	mA
Input Optical Power	-40	-25	10	dBm

* The current for maximum gain spectral width may vary by batch.



Gain Characteristics

@ CW, 25°C, 550 mA, input signal: -25 dBm at maximum gain wavelength

Parameter	Min.	Typ.	Max.	Unit
Small-Signal Gain @ 400 mA	26	30	—	dB
Saturated Output Power @ 400 mA (-3 dB)	10	15	—	dBm
Average Gain Wavelength	1005	1020	1035	nm
Gain Bandwidth (FWHM)	90	110	—	nm
Gain Spectrum Tilt	—	3	—	dB
Noise Figure	—	8	—	dB

Noise Figure Formula:

$$NF = 10 \log_{10}(2P_{ase}/Gh\nu)$$

[D. Baney et al., Fiber Technology, 6, 122 (2000)]

Amplified Spontaneous Emission (ASE) Characteristics

@ CW, 25°C, 550 mA, no input signal

Parameter	Min.	Typ.	Max.	Unit
Output Power (Per Port)	—	10	—	mW
Forward Voltage	—	1.6	1.9	V



Average Wavelength	—	1020	—	nm
Bandwidth (FWHM)	—	110	—	nm
Spectral Tilt	—	4	—	dB
Ground State Peak Position	—	1040	—	nm
Excited State Peak Position	—	970	—	nm
Ripple (RMS)**	—	0.02	0.5	dB
Polarization Extinction Ratio (PER)	15	18	—	dB
Polarization	—	TE	—	—

** Measured within 1 nm range near the spectral peak with 20 pm resolution.

Absolute Maximum Ratings

Parameter	Min.	Max.	Unit
Output Optical Power	—	450	mW
Input Optical Power	—	20	dBm
Forward Current	—	750	mA
Reverse Voltage	—	2	V



TEC Current	—	3	A
TEC Voltage	—	4	V
Chip Operating Temperature	10	40	°C
Housing Operating Temperature	0	70	°C
Storage Temperature	-40	85	°C
Lead Soldering Temperature (Max. 10 s, max housing temperature 120 °C)	—	300	°C
Fiber Bend Radius	3	—	cm

Typical performance (for reference only)

@CW, the case is mounted on room temperature heatsink

Gain spectra at different currents

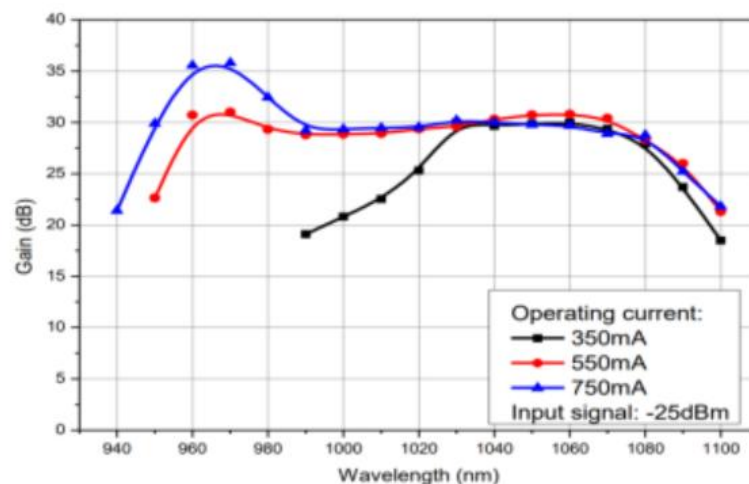



Gain and Output power vs. Input signal

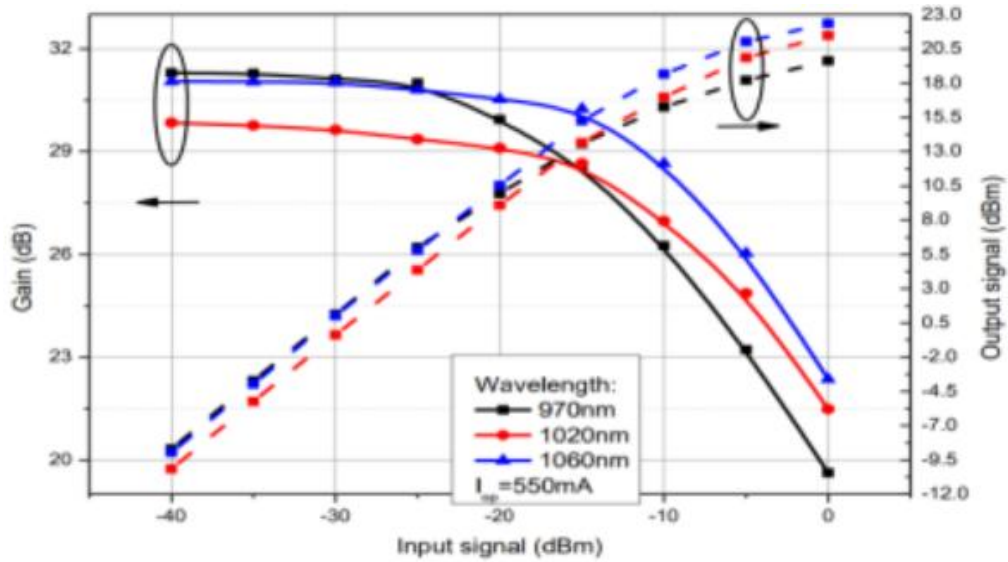

Gain spectra at different input signals

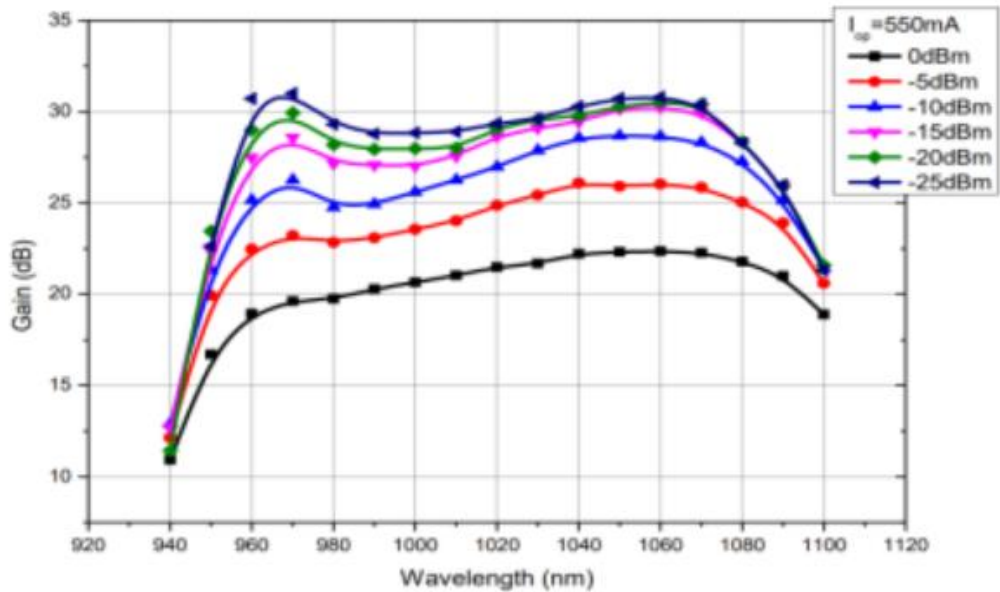

Spectra of amplified optical signal

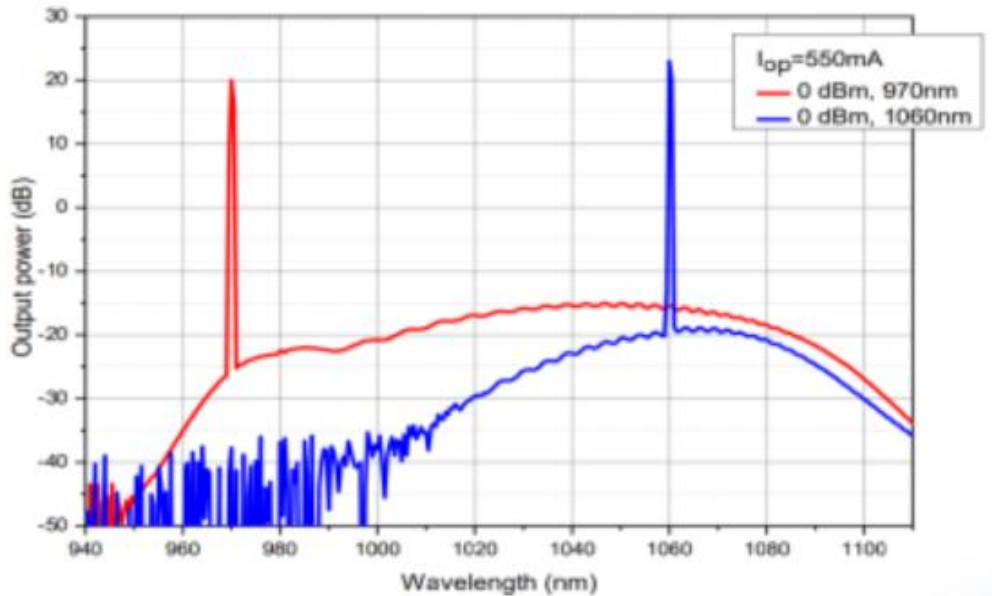

ASE spectra(no input signal)

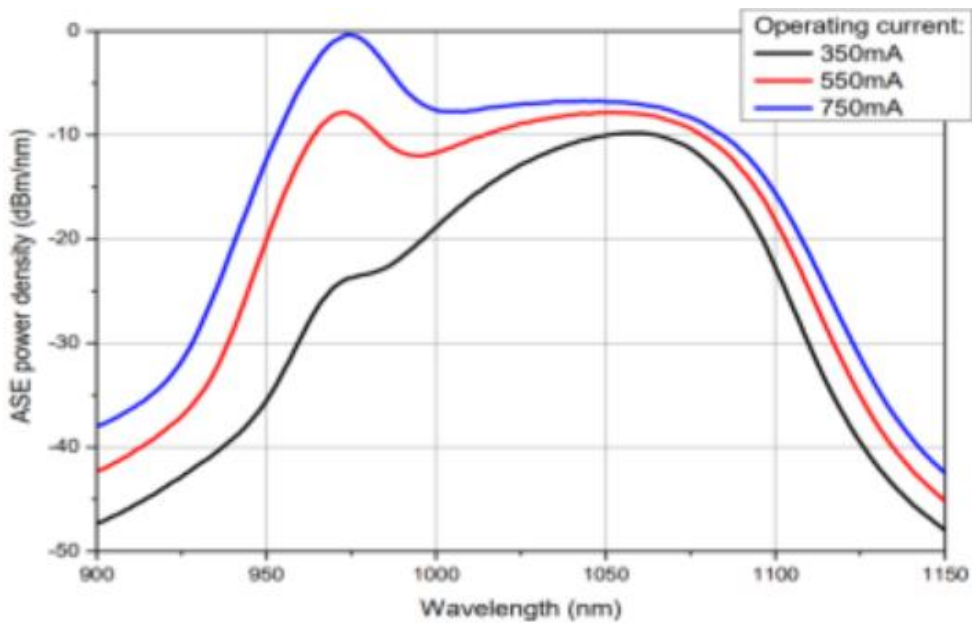

Output power at different input signals

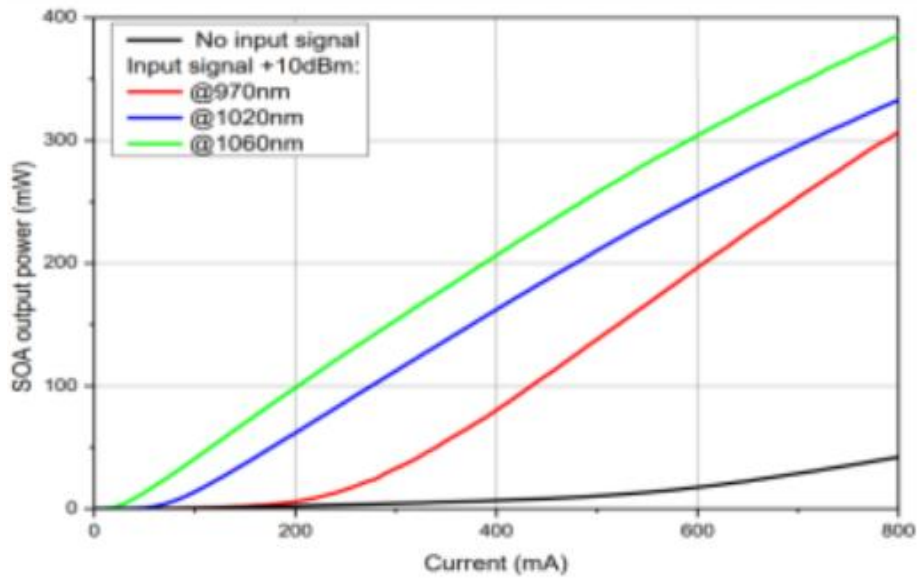

Thermistor Specifications			Fiber Specifications			
Parameter	Value	Unit	Parameter	PM980	HI1060	Unit
Type	NTC	—	Numerical Aperture, typical	0.12	0.14	—
Resistance @ 25 °C	10 ± 0.1	kΩ	Cutoff Wavelength	900 ± 70	920 ± 50	Nm
Beta (25–85 °C)	3435 ± 1%	K	Mode Field Diameter (@ 1060 nm)	6.6 ± 0.3	6.2 ± 0.3	μm



<p style="text-align: center;">R-T CURVE</p>	Cladding Diameter	125±1	125±1	µm
	Coating Diameter	245±15	245±15	µm
	Loose Tube Diameter (Optional)	900	900	µm
	Connector	FC/APC (narrow key)		
	Connector Alignment aligned with PANDA fiber			
<p style="text-align: center;"> Output light is polarized along the slow axis of the PM fiber. </p>				

Operating Instructions Safety and Operating Instructions

The light emitted by this device is invisible and harmful to human eyes. Do not look directly at the fiber connector during operation. Appropriate laser safety goggles must be worn when operating with the connector uncovered.

Absolute maximum ratings may only be applied to the device for a short time. Long-term operation at or simultaneous exposure to multiple maximum ratings may cause device damage and reduce reliability. Operation beyond the maximum ratings may lead to device failure and safety risks. A matched power supply shall be used to ensure that the maximum forward current is not exceeded.

Devices mounted on heat spreaders require a proper heat sink. Secure the device to the heat sink with four screws (cross-tightened with an initial torque of 0.075 N ·m and a final torque of 0.15 N ·m) or clamps. The flatness deviation of the heat sink surface shall be less than 0.05 mm. Indium foil or flexible thermal interface materials are recommended between the device base and the heat sink. Thermal grease is not recommended.

Avoid optical back-reflection, which may degrade spectral performance and power stability, and cause catastrophic facet damage. The use of an optical isolator is strongly recommended to suppress back-reflection.



Do not pull the optical fiber. Do not bend the fiber with a bending radius less than 3 cm. Protect the fiber end-face from contamination and damage during installation. After removing the dust cap, clean the fiber end-face in one direction with lens wipes or cotton swabs moistened with isopropyl alcohol or ethanol. Only operate the device with clean fiber connectors.

ESD Protection – Electrostatic discharge is a major cause of unexpected product failure. Strict ESD protection measures must be taken. Maintain ESD control during installation, including anti-static wristbands, grounded work surfaces and standardized anti-static operation procedures.

