

1090nm High-Gain Semiconductor Optical Amplifier

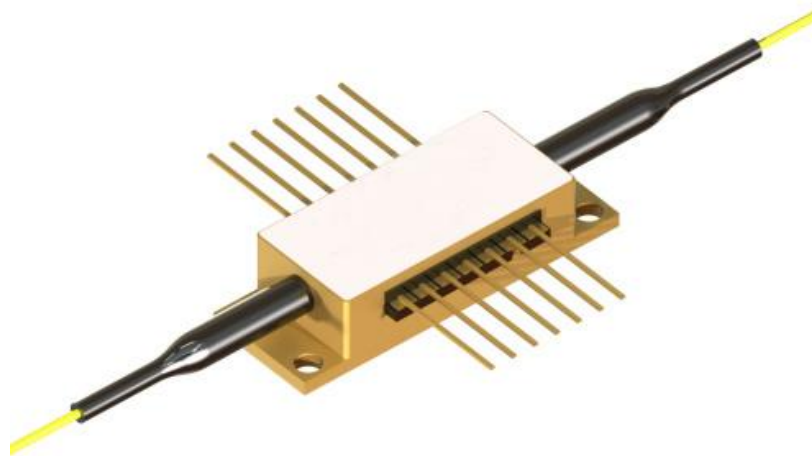

● Product Description

A high gain semiconductor optical amplifier optimized for the 1090nm wavelength band. By using proprietary anti reflective coating technology and ridge waveguide design, high fidelity and high gain amplification of weak optical signals can be achieved. This series of products features high gain, high saturation output power, and high polarization extinction ratio, and offers two product forms: high gain narrowband type (butterfly package, suitable for system integration) and high-power broadband type

(desktop module, built-in driver and control) to meet the diverse needs of scientific research experiments and commercial systems.

● Product features

High gain coefficient; narrowband optimized amplification; low-power operation; excellent signal-to-noise ratio; superior temperature stability

● Part Number

MP-SOA-1090-40db-25-XA

● Application area

Precision laser measurement | quantum optics experiment | fiber optic sensing system | medical diagnostic equipment | research-grade optical system

● Core parameters

Operating Wavelength	Operating Bandwidth
1090nm	25nm



● Dimension Drawing

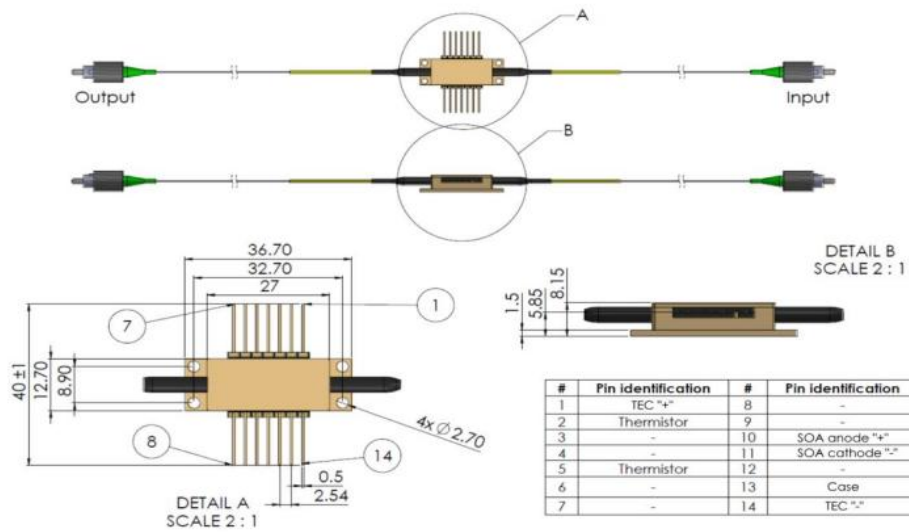

● General Parameters

Detailed Specifications

Recommended Operating Conditions

@ CW, housing mounted on a heat sink at room temperature

Parameter	Min.	Typ.	Max.	Unit
Chip Temperature	20	25	30	°C
Forward Current	—	400	500	mA
Input Optical Power	-40	-25	10	dBm

* The current for maximum gain spectral width may vary by batch.

Gain Characteristics

@ CW, 25°C, 400 mA, input signal: -25 dBm at maximum gain wavelength

Parameter	Min.	Typ.	Max.	Unit
Small-Signal Gain @ 400 mA	35	39	—	dB
Saturated Output Power @ 400 mA (-3 dB)	13	16	—	dBm
Average Gain Wavelength	1080	1090	1100	nm
Gain Bandwidth (FWHM)	20	25	—	nm
Noise Figure	—	7	—	dB

Noise Figure Formula :

$$NF = 10 \log_{10} (2P_{ase} / Gh\nu)$$

[D. Baney et al., Fiber Technology, 6, 122 (2000)]

Amplified Spontaneous Emission (ASE) Characteristics

@ CW, 25°C, 400 mA, no input signal

Parameter	Min.	Typ.	Max.	Unit
Output Power (Per Port)	—	40	—	mW
Forward Voltage	—	1.5	1.8	V
Average Wavelength	1080	1090	1100	nm
Bandwidth (FWHM)	20	25	—	nm
Ripple (RMS)**	—	0.03	0.2	dB
Polarization Extinction Ratio (PER)	13	16	—	dB
Polarization	—	TE	—	—

** Measured within 1 nm range near the spectral peak with 20 pm resolution.



Absolute Maximum Ratings

Parameter	Min.	Max.	Unit
Output Optical Power	—	500	mW
Input Optical Power	—	20	dBm
Forward Current	—	800	mA
Reverse Voltage	—	2	V
TEC Current	—	3	A
TEC Voltage	—	4	V
Chip Operating Temperature	10	40	°C
Housing Operating Temperature	0	70	°C
Storage Temperature	-40	85	°C
Lead Soldering Temperature (Max. 10 s, max housing temperature 120 °C)	—	300	°C
Fiber Bend Radius	3	—	cm



Typical performance(for reference only)

@CW, the case is mounted on room temperature heatsink

Gain spectra at different currents

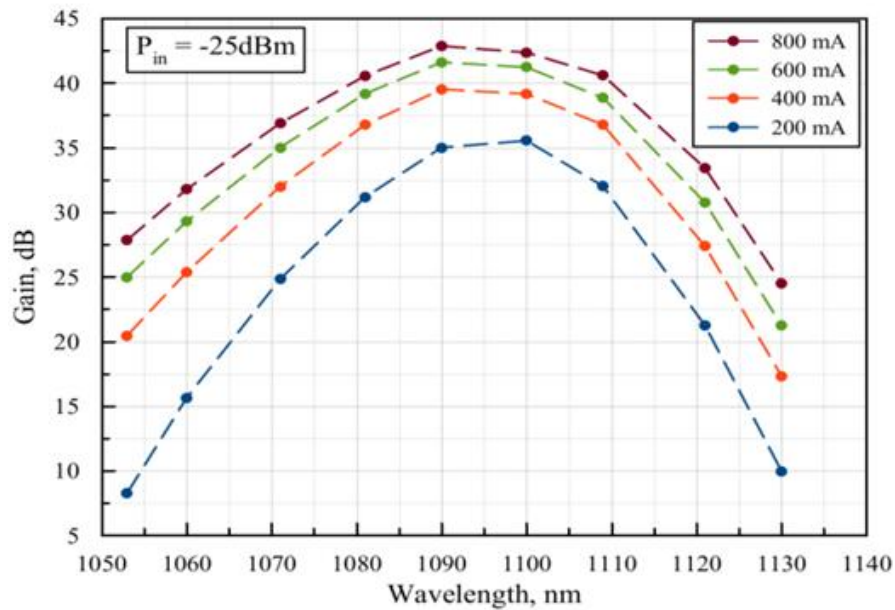

Gain and Output power vs. Input signal

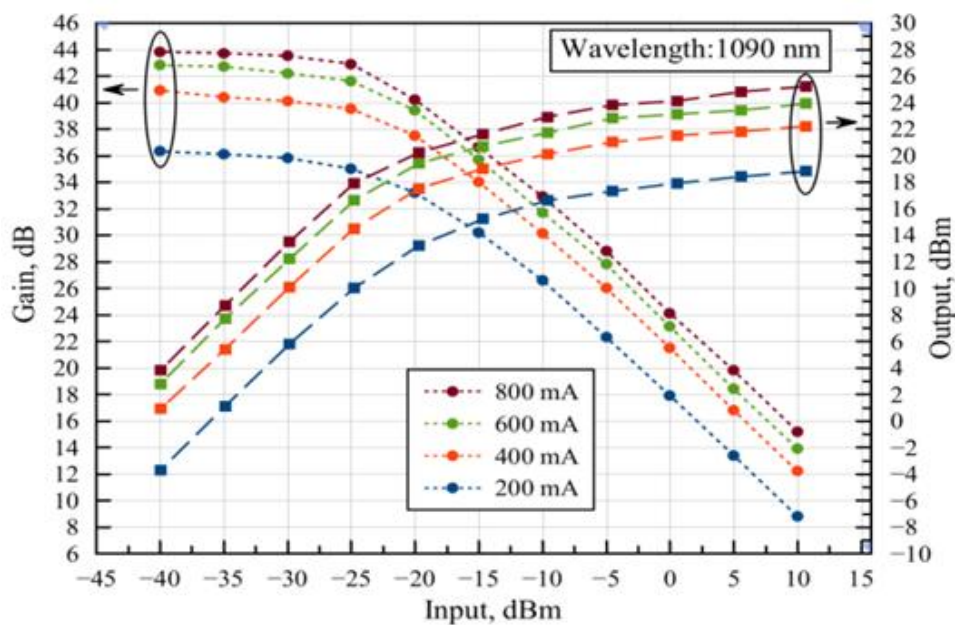

Gain spectra at different input signals

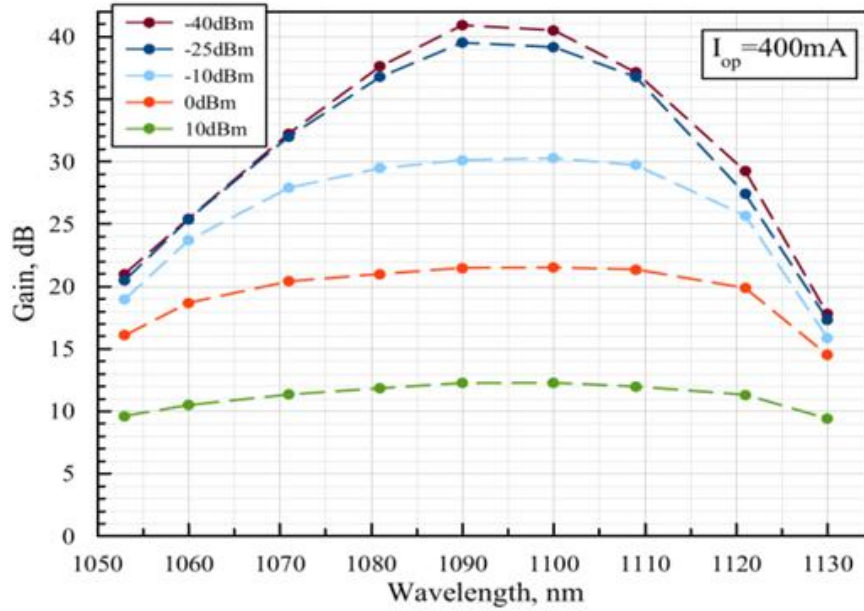

Spectra of amplified optical signals

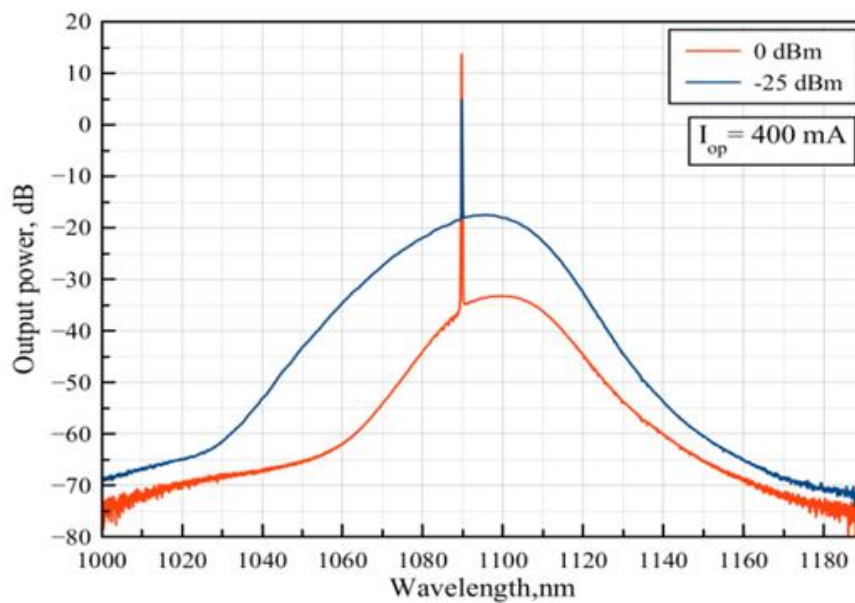

ASE spectra(no input signal)

ASE Spectra (no input signal)

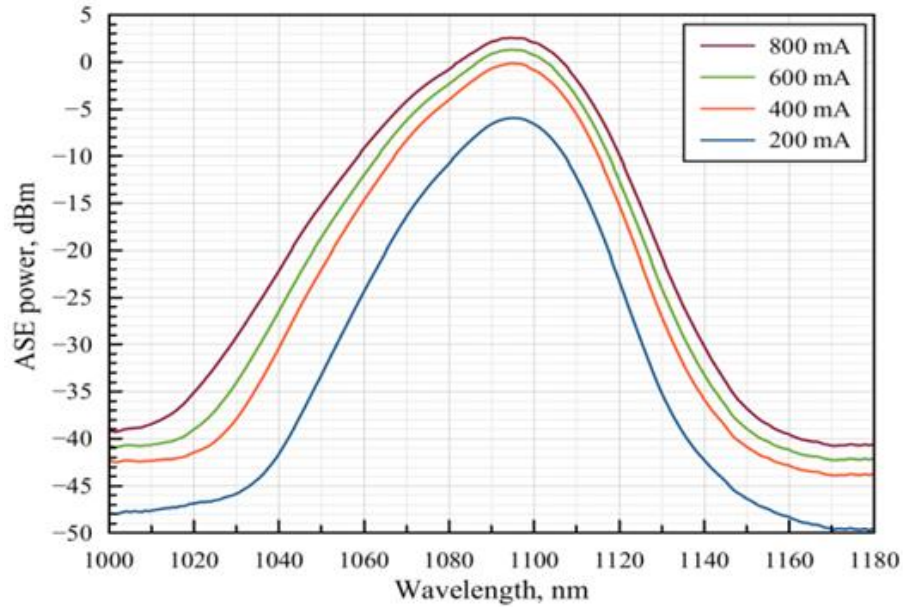

Output power at different input signals

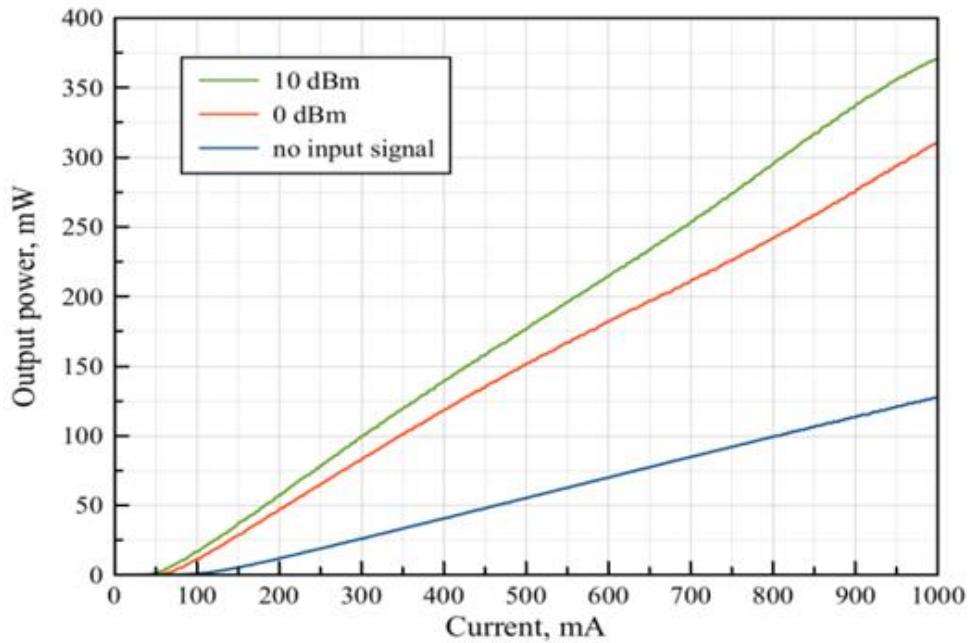

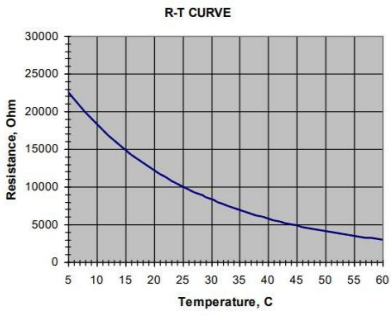
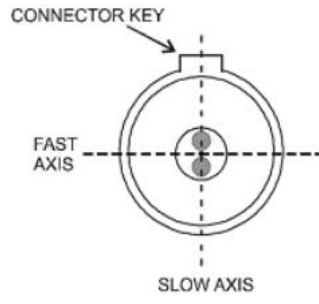

Thermistor Specifications			Fiber Specifications			
Parameter	Value	Unit	Parameter	PM980	HI1060	Unit
Type	NTC	—	Numerical Aperture, typical	0.12	0.14	—
Resistance @ 25 °C	10 ± 0.1	kΩ	Cutoff Wavelength	900 ± 70	920 ± 50	Nm
Beta (25–85 °C)	3435 ± 1%	K	Mode Field Diameter (@ 1060 nm)	6.6 ± 0.3	6.2 ± 0.3	μm
			Cladding Diameter	125 ± 1	125 ± 1	μm
			Coating Diameter	245 ± 15	245 ± 15	μm
			Loose Tube Diameter (Optional)	900	900	μm
			Connector	FC/APC (narrow key)		
			Connector Alignment aligned with PANDA fiber			
			 <p>Output light is polarized along the slow axis of the PM fiber.</p>			

Operating Instructions Safety and Operating Instructions

The light emitted by this device is invisible and harmful to human eyes. Do not look directly at the fiber connector during operation. Appropriate laser safety goggles must be worn when operating with the connector uncovered.

Absolute maximum ratings may only be applied to the device for a short time. Long-term operation at or simultaneous exposure to multiple maximum ratings may cause device damage and reduce reliability. Operation beyond the maximum ratings may lead to device failure and safety risks. A matched power supply shall be used to ensure that the maximum forward current is not exceeded.

Devices mounted on heat spreaders require a proper heat sink. Secure the device to the heat sink with four screws (cross-tightened with an initial torque of 0.075 N ·m and a final torque of 0.15 N ·m) or clamps. The flatness deviation of the heat sink surface shall be less than 0.05 mm. Indium foil or flexible thermal interface materials are recommended between the device base and the heat sink. Thermal grease is not recommended.

Avoid optical back-reflection, which may degrade spectral performance and power stability, and cause catastrophic facet damage. The use of an optical isolator is strongly recommended to suppress back-reflection.



Do not pull the optical fiber. Do not bend the fiber with a bending radius less than 3 cm. Protect the fiber end-face from contamination and damage during installation. After removing the dust cap, clean the fiber end-face in one direction with lens wipes or cotton swabs moistened with isopropyl alcohol or ethanol. Only operate the device with clean fiber connectors.

ESD Protection – Electrostatic discharge is a major cause of unexpected product failure. Strict ESD protection measures must be taken. Maintain ESD control during installation, including anti-static wristbands, grounded work surfaces and standardized anti-static operation procedures.

