

1270nm 200mW TypeA Gain Chip (TO Package)



● Product Description

A type A (straight stripe) gain chip with TO packaging, with a center wavelength of 1270nm, designed specifically for external cavity semiconductor lasers. The chip is coated with high reflectivity (HR) and anti reflectivity (AR) coatings on both end faces, and must rely on external frequency selective elements (such as diffraction gratings) to generate laser light, thereby achieving a wide tuning range and high edge mode suppression ratio.

● Product features

TO package; High gain efficiency; wide tuning range; low noise; Easy to integrate

● Part Number

MP-GC-1270-60-200-To-A

● Application area

Fiber Optic Communication | LiDAR | Medical Devices | Sensing Systems |

Industrial Processing

● Core parameters

Center wavelength	Tuning range	Output power	Forward current
1270nm	60nm	200mW	800mA

● Dimension Drawing

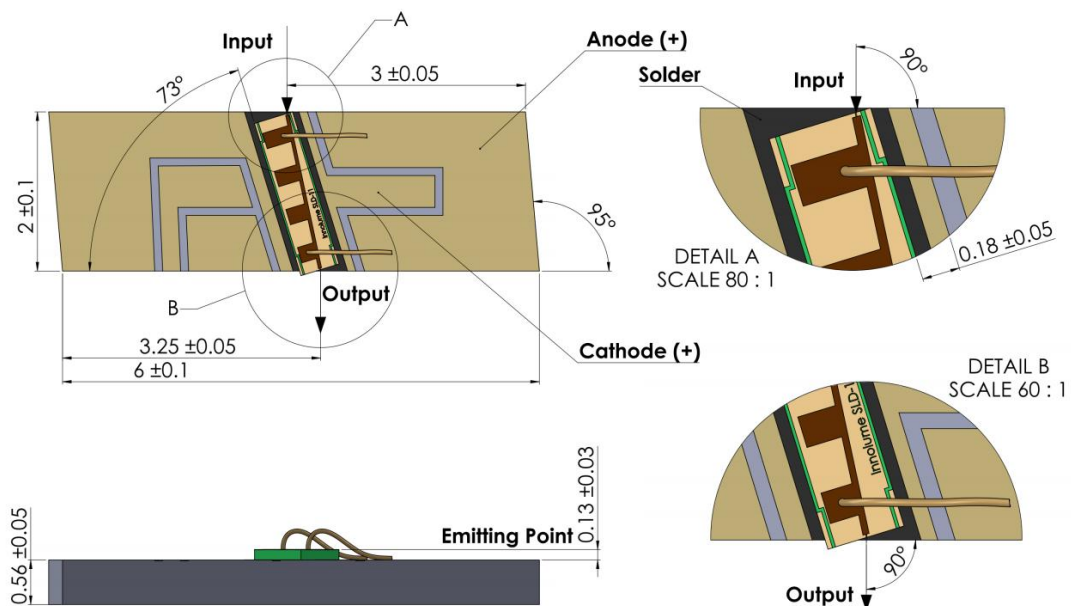



● General Parameters

Recommended operating conditions

Parameters	Min. value	Typical values	Max. value	unit
Radiator temperature	20	25	30	°C
Forward current*			800	mA
Optical feedback**		20		%

*Reach Max. No self-excited laser is generated when the current is current

** Coupling efficiency with chip is not included

Tunable characteristics

Batch Qualified @ CW, 25C, 800mA, Outer Cavity with Littman Configuration

with 20% Feedback

Parameters	Min. value	Typical values	Max. value	unit
Max. Power wavelength	1255	1270	1285	nm
The output power @780nm	150	200		mW
Tuning range center wavelength	1255	1270	1285	nm
Tuning range width (full)		60		nm
The side-mode suppression ratio (SMSR) is @780nm		55		dB

Amplified spontaneous radiation (ASE) characteristics

Test each sample @ CW, 25C, 800mA, no feedback

Parameters	Min. value	Typical values	Max. value	unit
Output power		2.5		mW
Forward voltage		1.8	2	V
Average wavelength		1265		nm
Bandwidth (FWHM)*		22		nm
Fast axis beam divergence (FWHM).	28	33	38	deg
Slow axis beam divergence (FWHM).	4	6	11	deg
polarization		TE		

*Radiation is coupled in a lensless single-mode fiber and measured at 1 nm resolution by OSA.

Chip parameters

Parameters	Min. value	Typical values	Max. value	unit
Chip length		3		mm
Backward reflection on the front			0.1	%
Back reflection on the back	90	99		%

Due to Max. Rated parameters

Parameters	Min. value	Max. value	unit
Forward current @ 20% feedback		1000	mA
Optical feedback (excluding coupling with chip)		30	%
Reverse voltage		1	V
Operating temperature (above dew point)	-10	60	°C
Storage temperature (in its original sealed packaging)	-40	85	°C

Drawings

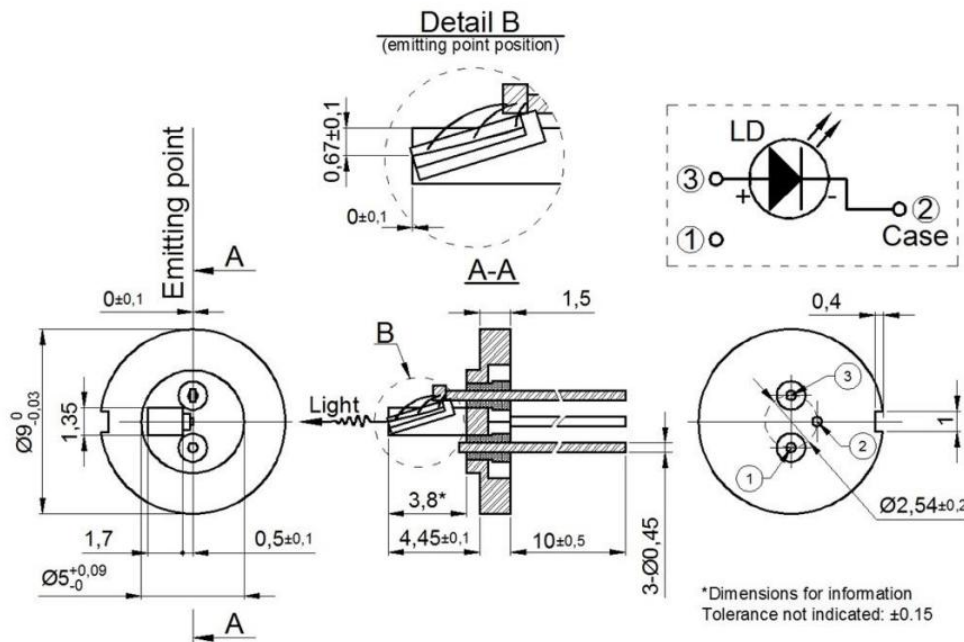

General parameters

There are two types of outer cavity lasers that use diffraction gratings: Littrow and Littman/Metcalf. The primary diffraction light of the Littrow type diffraction grating is fed directly into the semiconductor laser and oscillated by resonating with the low-reflection film (LR) of the vertical end face. Since diffraction is performed only once, a larger optical output than the Littman type is obtained.

Wavelengths are scanned by rotating the grating. Generally speaking, an intracavity achromatic lens is used to collimate a larger area of the extended beam on the grating. The zero-stage diffraction beam can be used as an output laser beam. The product line of Innvolume gain chips can be subdivided into two main categories:

- Single-sided optical access (types A and B)
- Duplex optical access (types C and D)

In a scheme where the output power is coupled from the outer cavity to the outside, the single-sided fiber access gain chip is the ideal working element. Typically, they are packaged in a transistor form factor can. Bilateral fiber access gain chips can be used in scenarios where power output coupling from the gain chip end-face is performed to reduce optical loss, or in light amplification scenarios.

Type A gain chips have straight stripes perpendicular to the end face with highly reflective and anti-reflective coatings. This is a cost-effective solution for constructing external cavity diode lasers. The A-type gain chip has a symmetrical beam far-field and uses aspherical lenses with high numerical apertures to provide effective coupling to the outer and rear cavities. This type of gain chip has relatively low gain spectral ripple suppression compared to other types, which is due to the reflectivity of the anti-reflective coating at the level of 0.1% and can be further reduced by bending the fringe to the end face design.

The B-type gain chip has curved stripes, high reflectivity on the normal side, and deep reflectivity coating on the oblique side. The curved stripes and

anti-reflective coating provide extremely low reflectivity ($< 10E-5$), allowing suppression of self-laser and Min. The transformation is increasing and undulating. The disadvantage of curved fringes is the distortion of the output beam, which makes collimation difficult and reduces the efficiency of reverse coupling. Therefore, it is necessary to use optics with high numerical apertures.

The C-type gain chip has curved stripes and an anti-reflective coating on the inclined side and a few percent reflectivity on the normal side. The wavelength selection feedback must be set on the tilt side (the same advantages and disadvantages as the Type B), while the output power is output from the normal side. This design results in high output power and better output beam. End-face reflections with normal stripes must be designed separately according to the system configuration and the required output power.

D-type gain chips have a slanted stripe with anti-reflective coatings on both sides, often suitable for advanced optical schemes that require a built-in magnification unit. Innovative facet coating technology, including facet passivation, meets high reliability requirements. Compliant with the production standards of ISO9001:2008 and is the result of careful design and manufacturing and extensive testing. Each device is individually tested and comes with a set of test data.

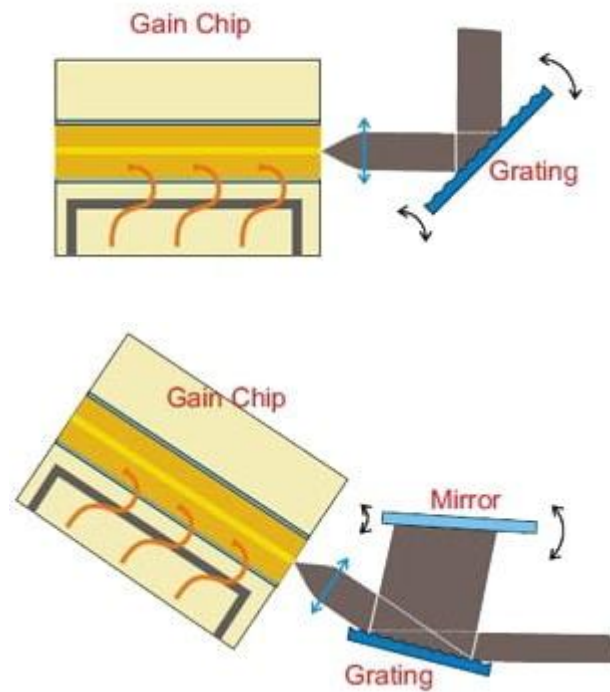
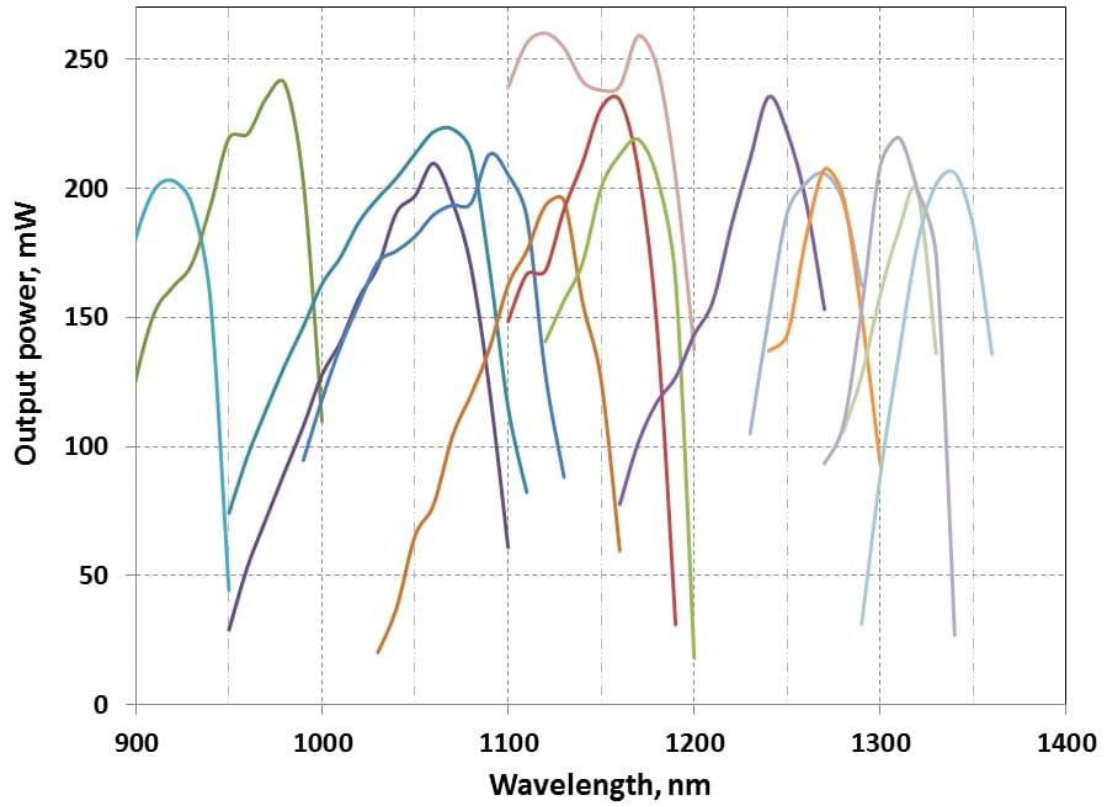

Characteristic curves

Typical performance of the outer lumen (for reference only)

@CW, recommended working conditions, Littman configuration

Optical Spectra(res. 0.5nm)

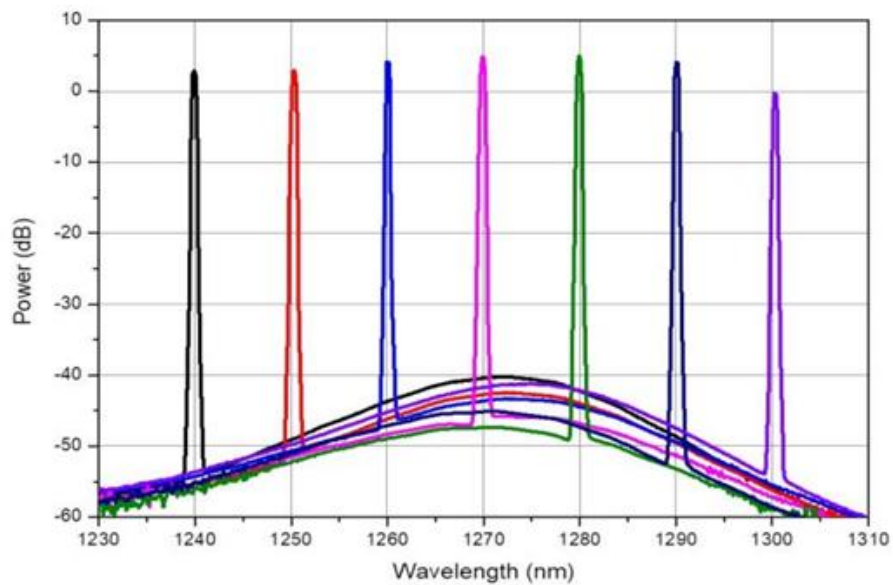

Optical Spectra(res. 10pm)

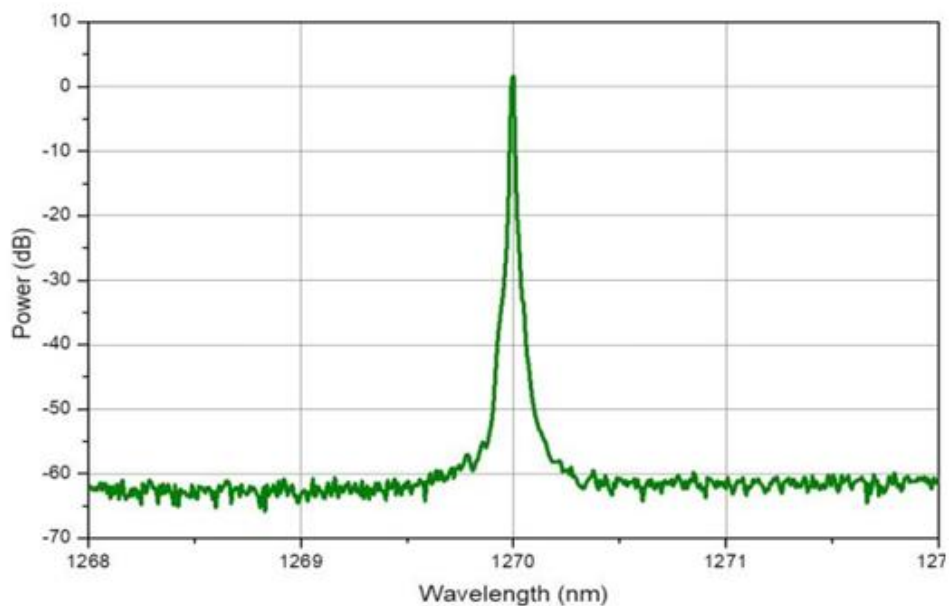



Output Power Spectra

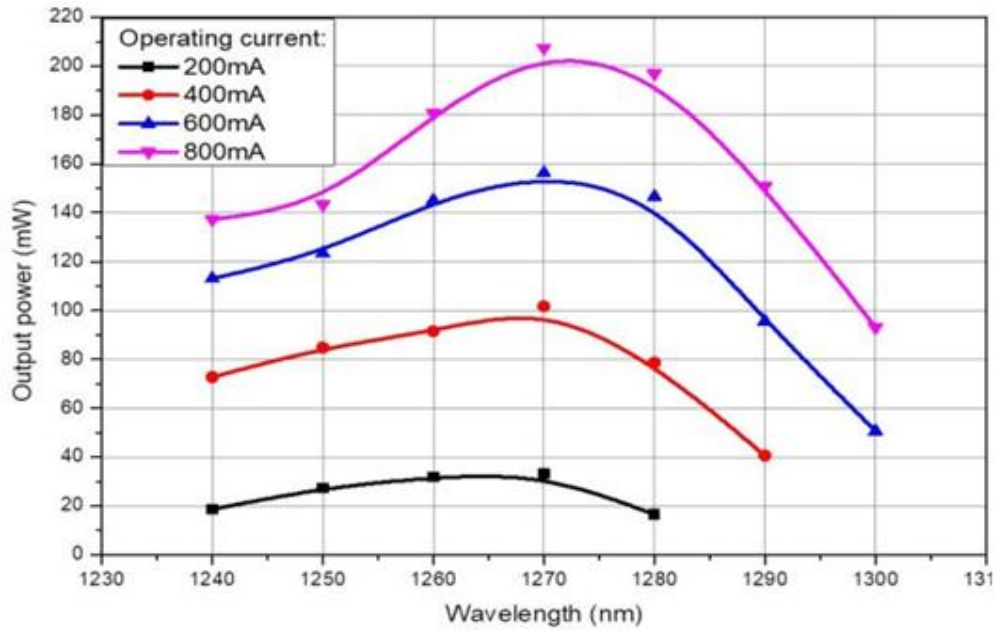

Intergrated Signal/ASE ratio

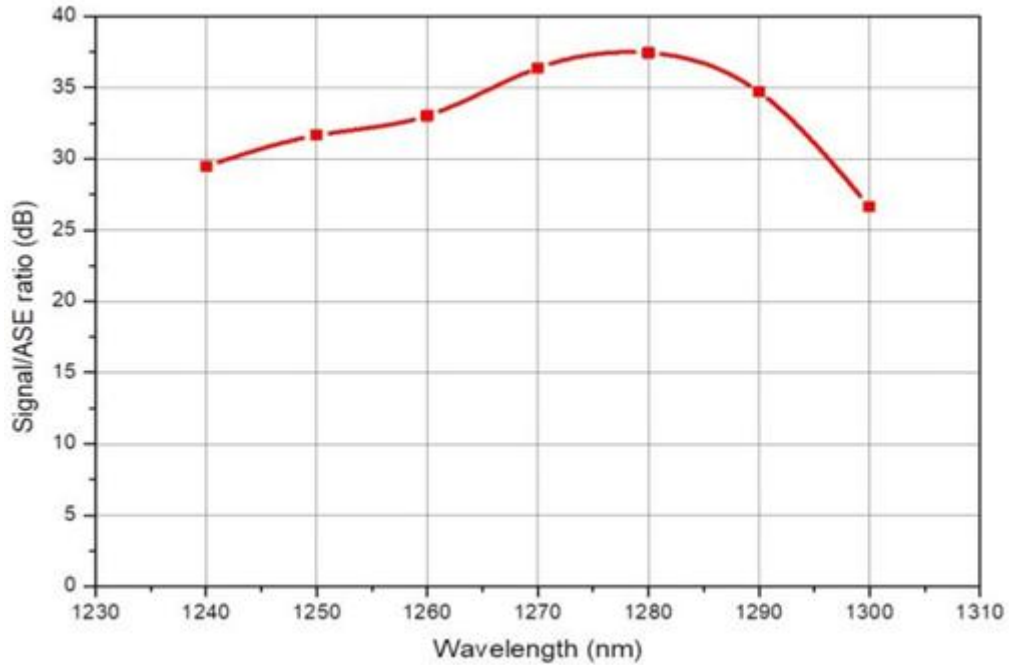

Output Power@1190nm

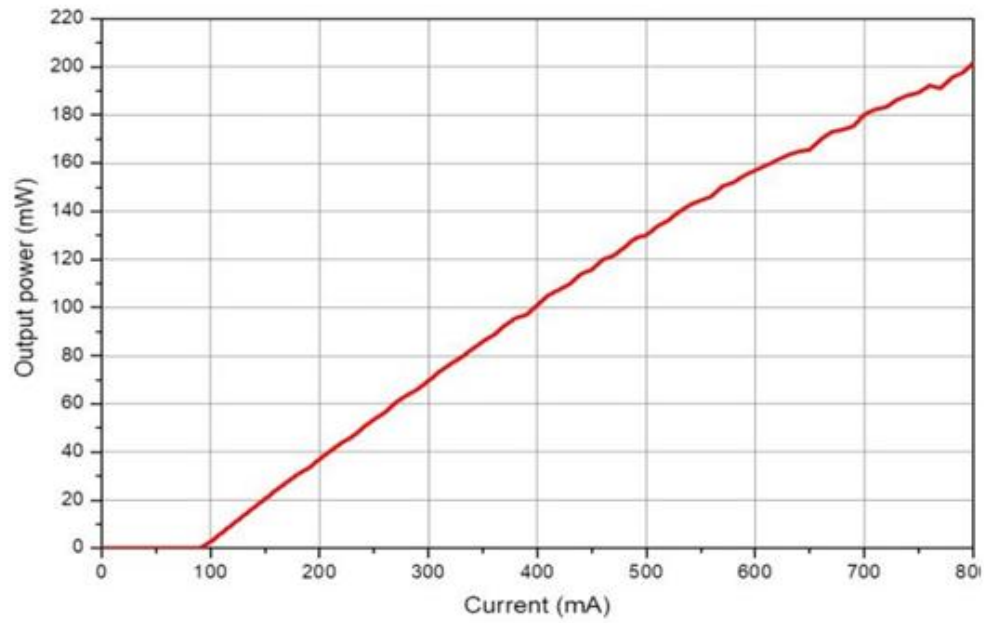

Threshold Current

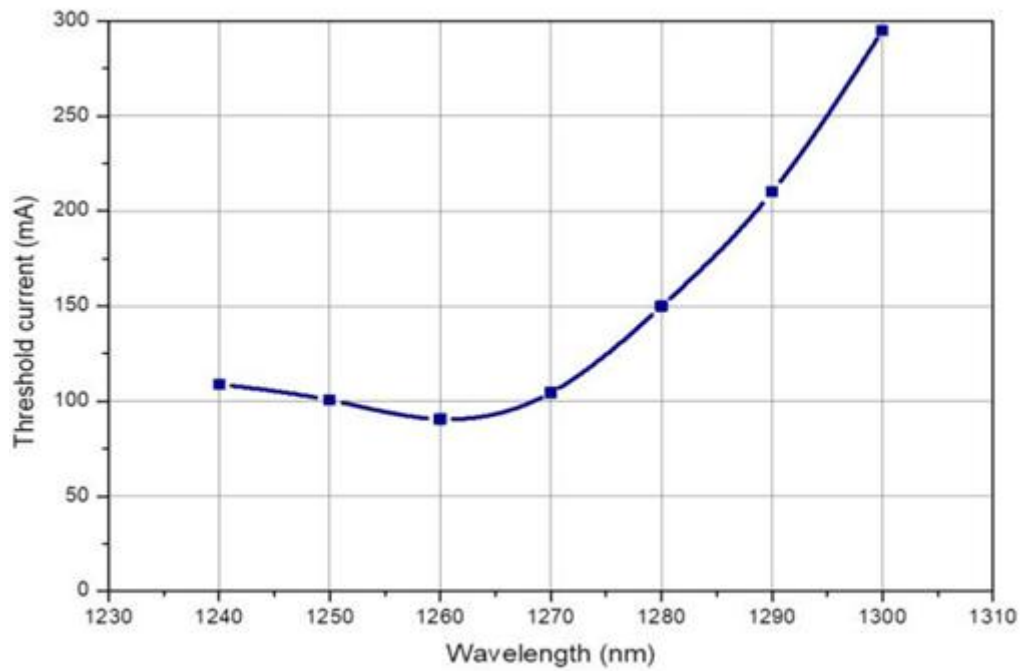

Typical Performance without feedback(for reference only)

L-I-V curve

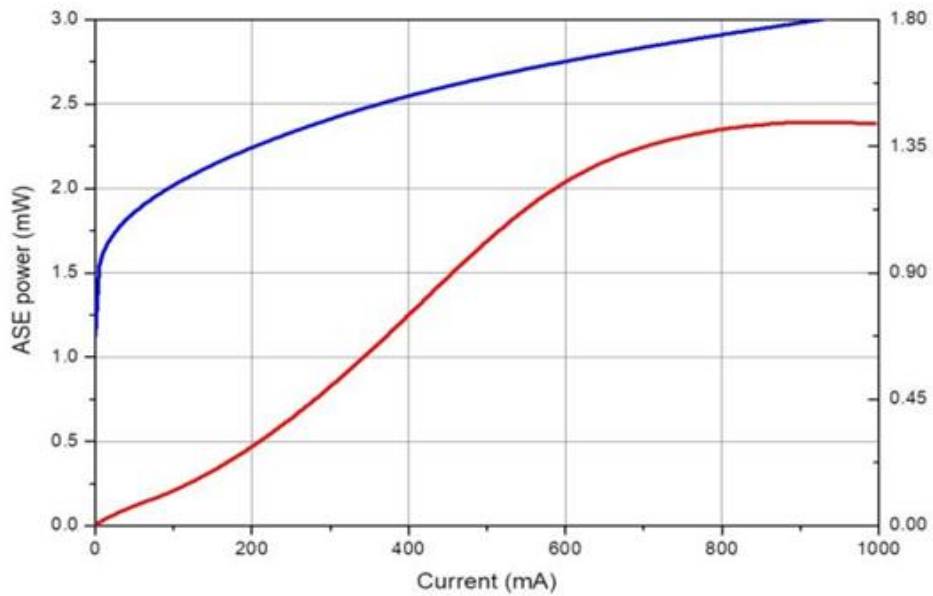

ASE Spectra(res. 1nm)

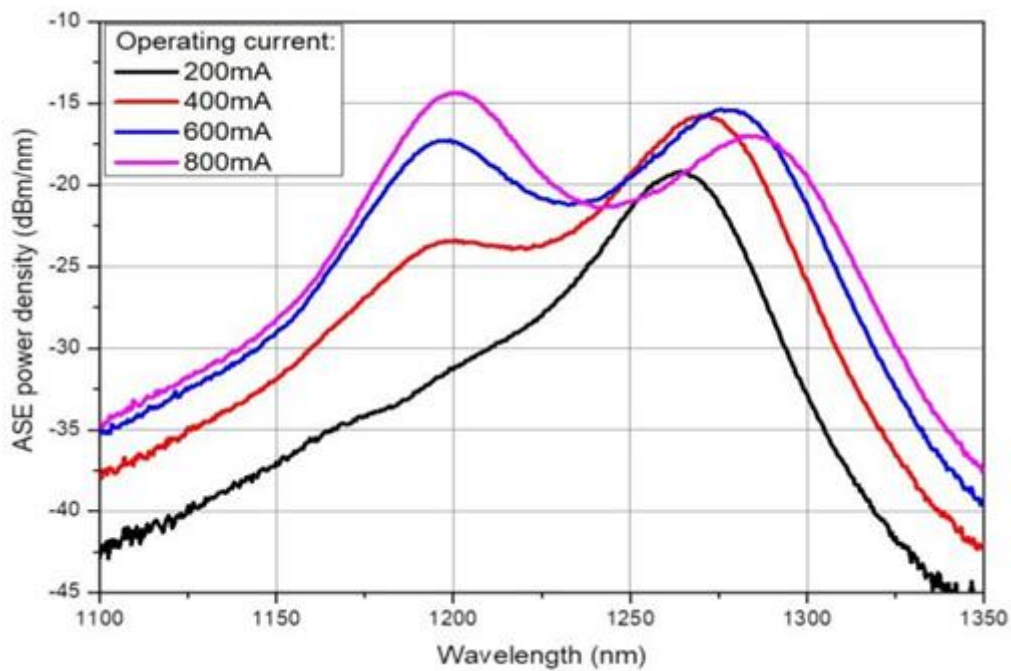

Operating instructions

Safety and operating instructions

The laser emitted by this device is invisible and dangerous to the human eye.

When the device is in operation, avoid looking directly at the fiber output or collimating beam along its optical axis. Appropriate laser safety glasses must be worn during operation.

Due to Max. The rating can only be applied to the device for a short period of time.

Prolonged exposure to Max. rated or exposed to more than one or more Max.

Ratings may cause damage to the device or affect the reliability of the device.

Operation outside of the product's Max. rating may result in equipment failure or safety hazards. The power supply used with the device must be used for Max.

The peak optical power does not exceed. The equipment on the heat radiator needs to be equipped with an appropriate heat sink, and it is essential to ensure that the heat sink has adequate heat dissipation and thermal conductivity.

The device is an open heat sink laser diode; Operate only in clean air or dust-proof enclosures. The operating temperature and relative humidity must be controlled to avoid condensation of water droplets on the laser surface. Any contamination or contact with the laser surface must be avoided.

ESD Protection - Electrostatic discharge is the leading cause of unexpected product failure. Take extreme precautions to prevent ESD. When handling products, use wristbands, grounded work surfaces, and strict anti-static technology.

