

1325nm 200mW TypeB Gain Chip (TO Package)



● Product Description

This product is a high-performance B-type gain chip with a standard TO package and a central wavelength of 1325nm. Its core design features a bent grating waveguide structure, specifically optimized for external cavity diode lasers (ECDL), aiming to achieve exceptional self-excitation suppression and broad spectral tuning capability.

● Product features

TO package; high gain efficiency; wide tuning range; low noise; easy integration

● Part Number

MP-GC-1325-60-200-To-B

● Application area

Optical fiber communication | LiDAR | Medical equipment | Sensing system |

Industrial processing

● Core parameters

Center wavelength	Tuning range	Output power	Forward current
1325nm	60nm	200mW	800mA

● Dimension Drawing

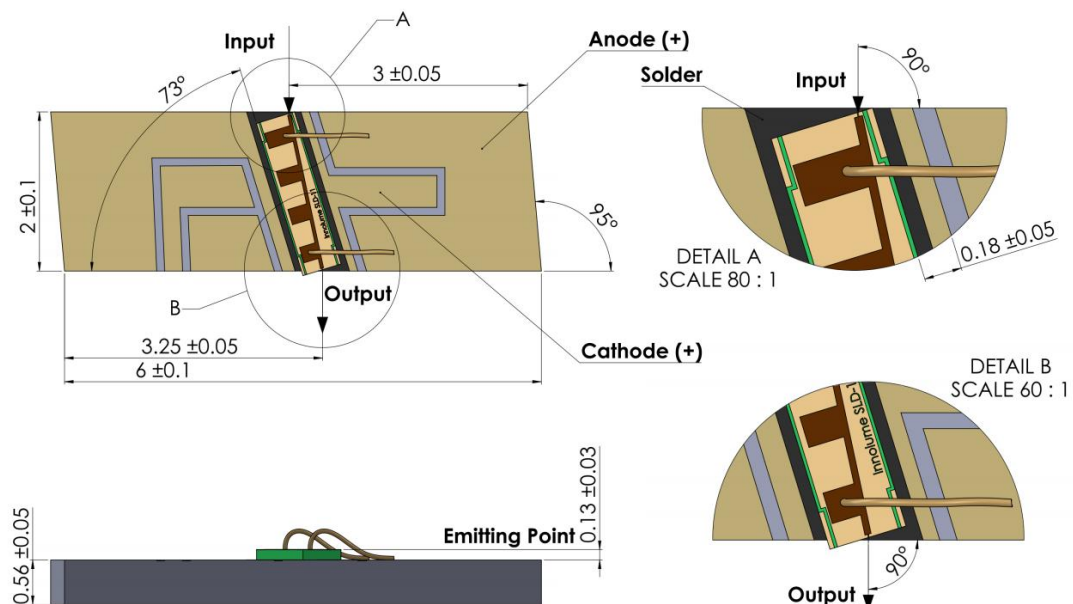



● General Parameters

Recommended Operating Conditions

Parameter	Min.	Typ.	Max.	Unit
Heat Sink Temperature	20	25	30	°C
Forward Current*	—	—	800	mA
Optical Feedback**	—	20	—	%

* No self-lasing occurs at maximum current.** Excludes chip coupling efficiency.

Tuning Characteristics

Batch qualified under CW, 25 ° C, 800 mA, external cavity with Littman configuration and 20% optical feedback.

Parameter	Min.	Typ.	Max.	Unit
Maximum Power Wavelength	1300	1320	1320	nm
Output Power @ 780 nm	150	200	—	mW
Center Wavelength of Tuning Range	1290	1300	1310	nm
Full Tuning Range Width	—	60	—	nm
Side Mode Suppression Ratio (SMSR) @ 780 nm	—	55	—	dB



Amplified Spontaneous Emission (ASE) Characteristics

Each device tested under CW, 25 °C, 800 mA, no optical feedback.

Parameter	Min.	Typ.	Max.	Unit
Output Power	—	1.5	—	mW
Forward Voltage	—	1.7	2	V
Average Wavelength	—	1245	—	nm
Bandwidth (FWHM)*	—	25	—	nm
Fast-Axis Beam Divergence (FWHM)	35	38	45	deg
Slow-Axis Beam Divergence (FWHM)	5	6	11	deg
Polarization	—	TE	—	—

* Radiative coupling into unlensed single-mode fiber, measured by OSA with 1 nm resolution.



Chip Parameters

Parameter	Min.	Typ.	Max.	Unit
Chip Length	—	3	—	mm
Front Facet Back Reflection	—	—	0.1	%
Rear Facet Back Reflection	90	99	—	%

Absolute Maximum Ratings

Parameter	Min.	Max.	Unit
Forward Current @ 20% Feedback	—	1000	mA
Optical Feedback (Excluding Chip Coupling)	—	30	%
Reverse Voltage	—	1	V
Operating Temperature (Above Dew Point)	-10	60	°C
Storage Temperature (Original Sealed Package)	-40	85	°C

Drawings

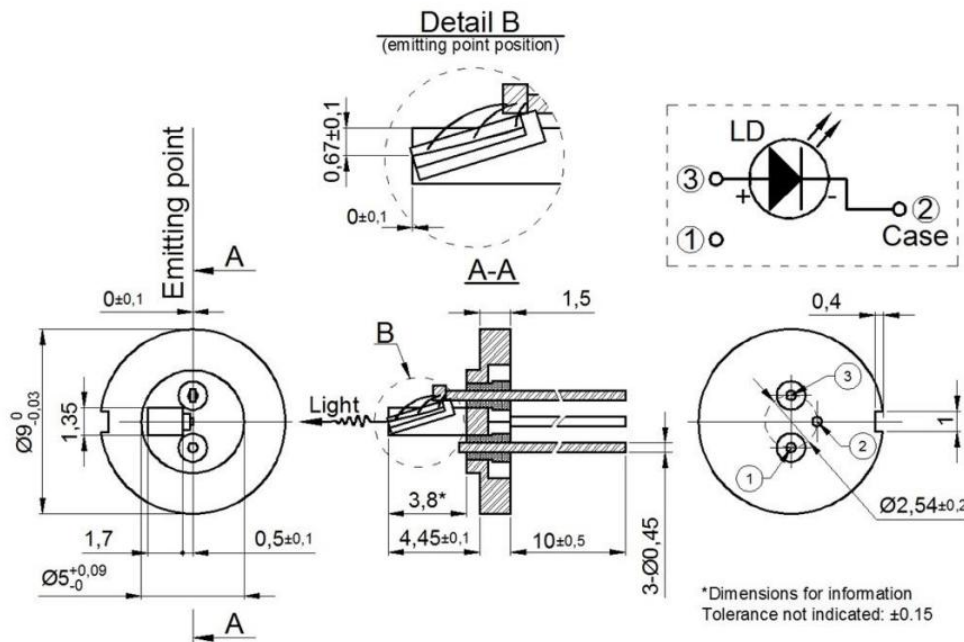

General Specifications

There are two types of external cavity lasers utilizing diffraction gratings: the Littrow configuration and the Littman/Metcalf configuration. In the Littrow structure, the first-order diffracted light from the grating is directly fed back into the semiconductor laser, and laser oscillation is realized through resonance with the low-reflection (LR) coated vertical facet. Since diffraction occurs only once, a higher optical output can be obtained compared with the Littman scheme.

Wavelength scanning is realized by rotating the diffraction grating. In general, an intra-cavity achromatic lens is adopted to collimate the expanded beam covering a large area on the grating. The zero-order diffracted beam serves as

the output laser beam. The product line of Innvolume gain chips is divided into two main categories:

Single-sided optical access (Type A & Type B)

Double-sided optical access (Type C & Type D)

Single-fiber-access gain chips are ideal components for schemes where output power is coupled outwards from the external cavity. They are commonly packaged in transistor outline can housings. Dual-fiber-access gain chips are applicable in solutions that realize power output coupling from the gain chip facets to reduce optical loss, or in optical amplification systems.

Type A gain chips feature straight stripes perpendicular to the chip facets, with high-reflection and anti-reflection coatings. They provide a cost-effective solution for constructing external cavity diode lasers. Featuring symmetric far-field beam profiles, Type A chips achieve efficient coupling with external cavities and rear cavities when paired with high-numerical-aperture aspherical lenses. This type exhibits relatively limited gain spectrum ripple suppression, as the reflectivity of the anti-reflection coating is maintained at approximately 0.1%. The residual reflectivity can be further reduced via curved stripe-to-facet design optimization.

Type B gain chips are designed with curved stripes, adopting a high-reflection coating on the normal facet and a deep anti-reflection coating on the tilted facet. The combination of curved stripes and advanced anti-reflection coatings

delivers ultra-low facet reflectivity ($< 10E-5$), effectively suppressing self-lasing and minimizing gain fluctuation. A drawback of curved stripes is output beam distortion, which complicates beam collimation and reduces reverse coupling efficiency. High-numerical-aperture optical elements are therefore mandatory for practical operation.

Type C gain chips incorporate curved stripes and anti-reflection coatings on the tilted facet, with a moderate reflectivity of several percent on the normal facet. Wavelength-selective optical feedback is configured on the tilted side, sharing the same merits and limitations as Type B, while optical power is extracted from the normal facet. This configuration enables high output power and superior beam quality. The reflectivity of straight-stripe facets needs customized optimization according to system configurations and target output power.

Type D gain chips adopt tilted stripes with anti-reflection coatings on both facets, primarily designed for advanced optical systems requiring integrated amplification units. Innovative facet coating technology combined with facet passivation ensures long-term operational reliability. Manufactured in compliance with ISO9001:2008 standards, all products undergo rigorous design, standardized fabrication and comprehensive testing. Each device is individually characterized and delivered with complete test data reports.

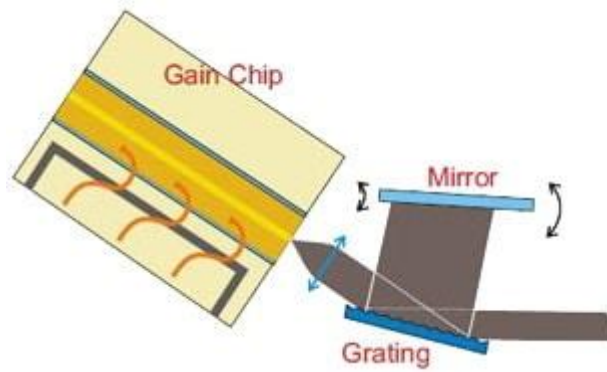
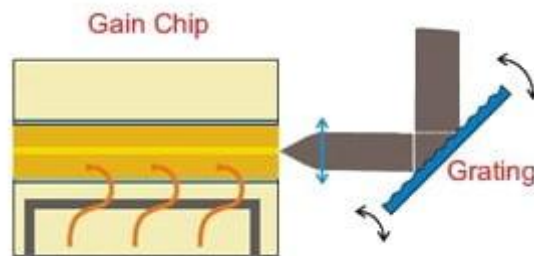
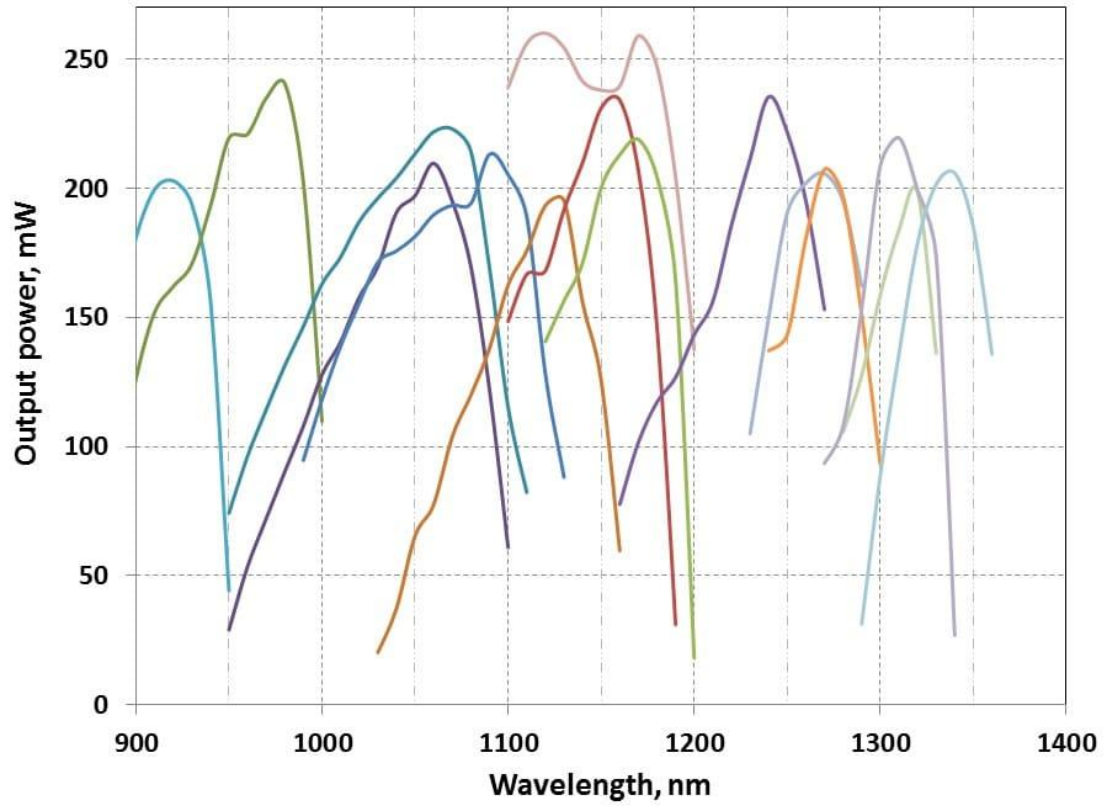

Characteristic Curves

Typical Performance (For Reference Only)

Optical Spectrum(res.0.5 nm)

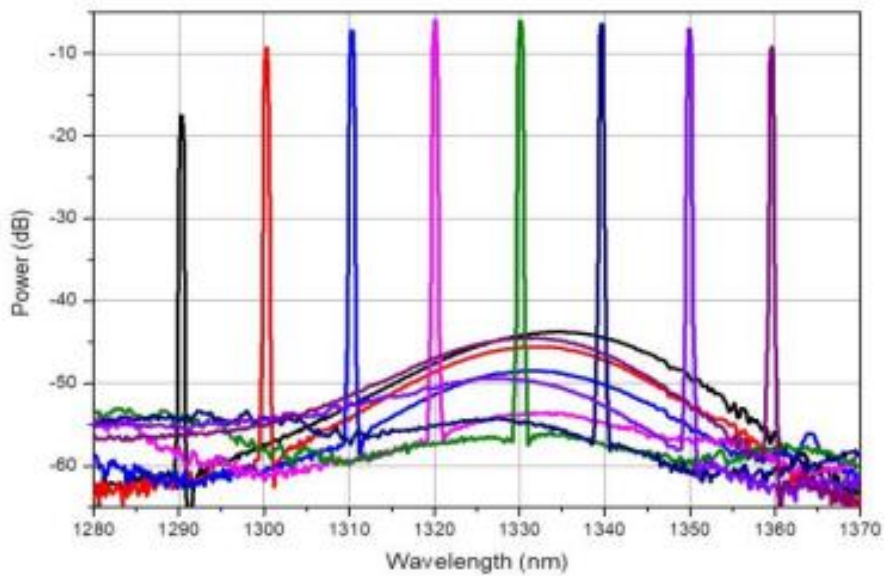

Optical Spectrum(res.10 pm)

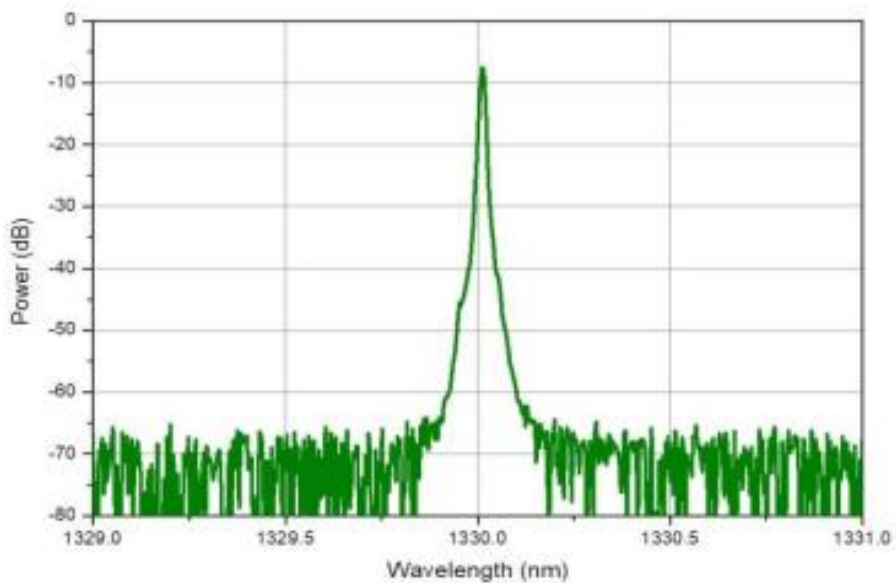

Output Power Spectrum

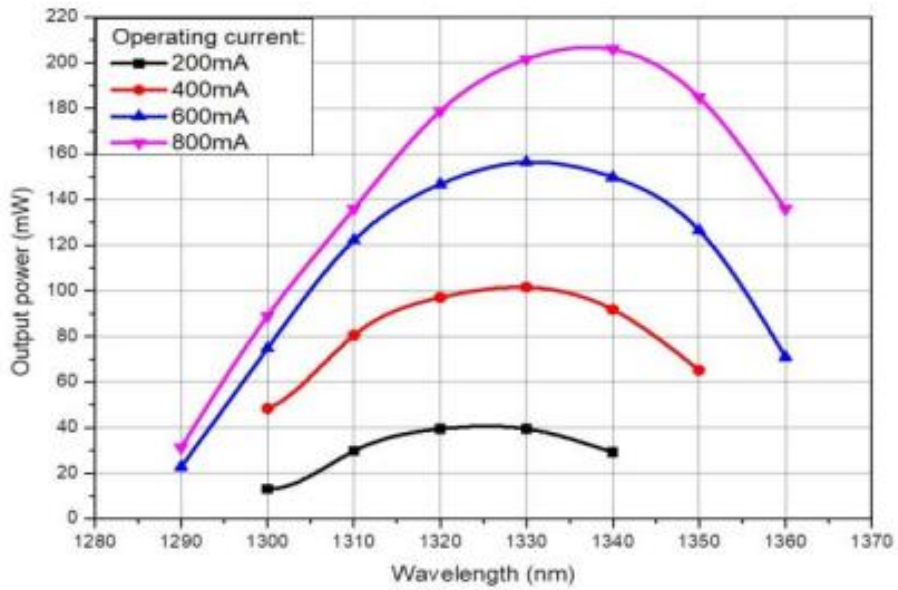

Integrated Signal/ ASE Ratio

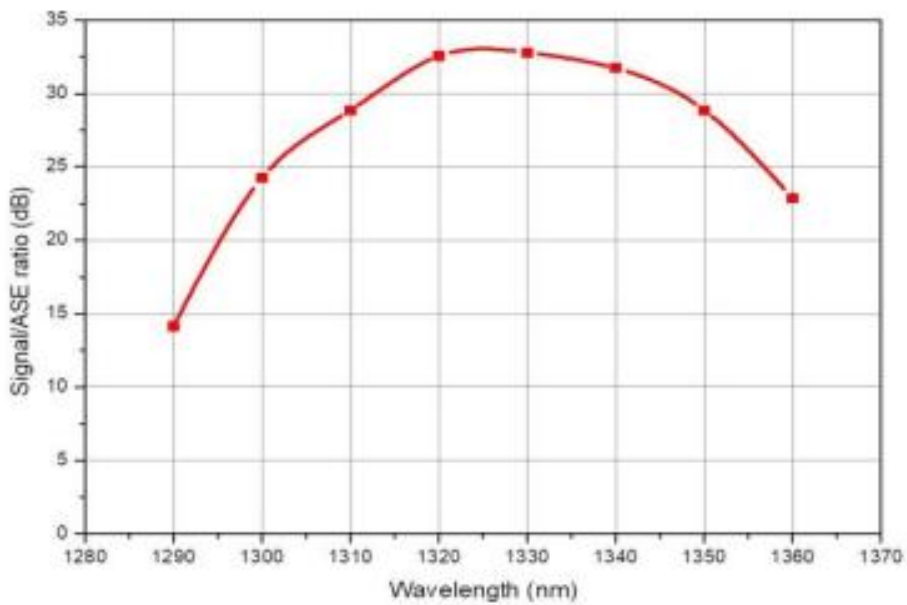

Output Power@780nm

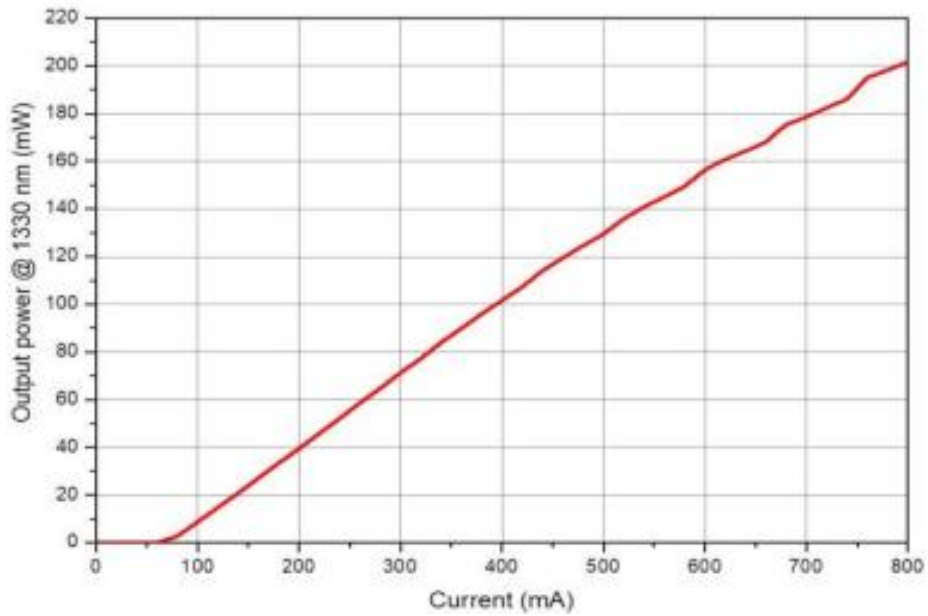

Threshold Current

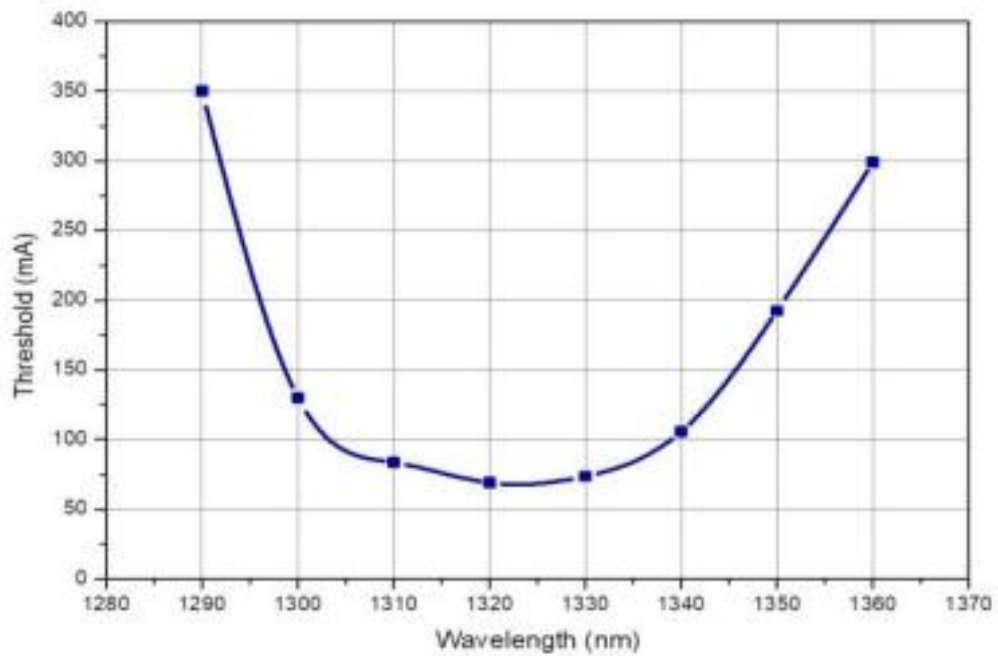

Typical Performance without Feedback (For reference only)

L-I-V Curve

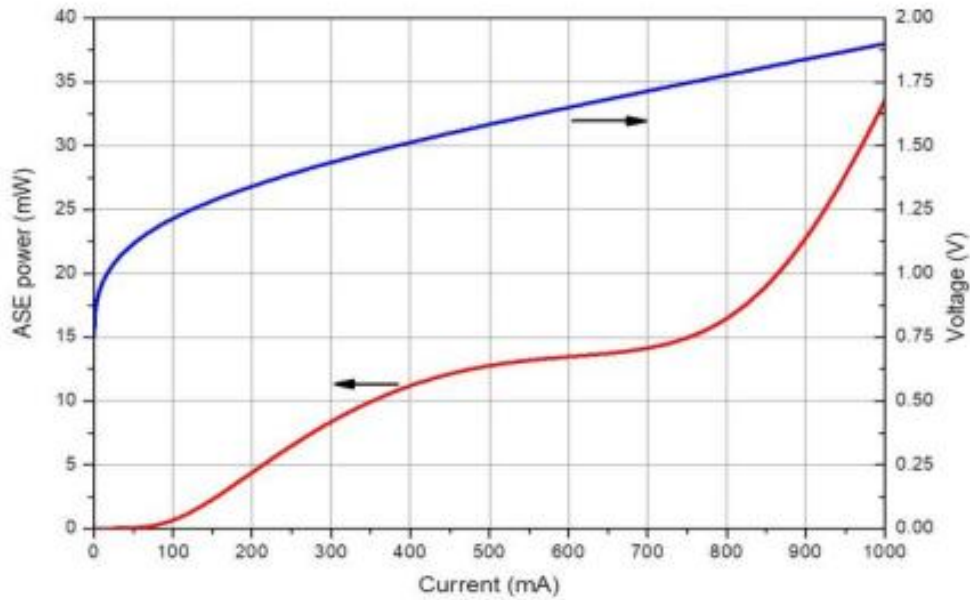

ASE Spectrum (res 1nm)

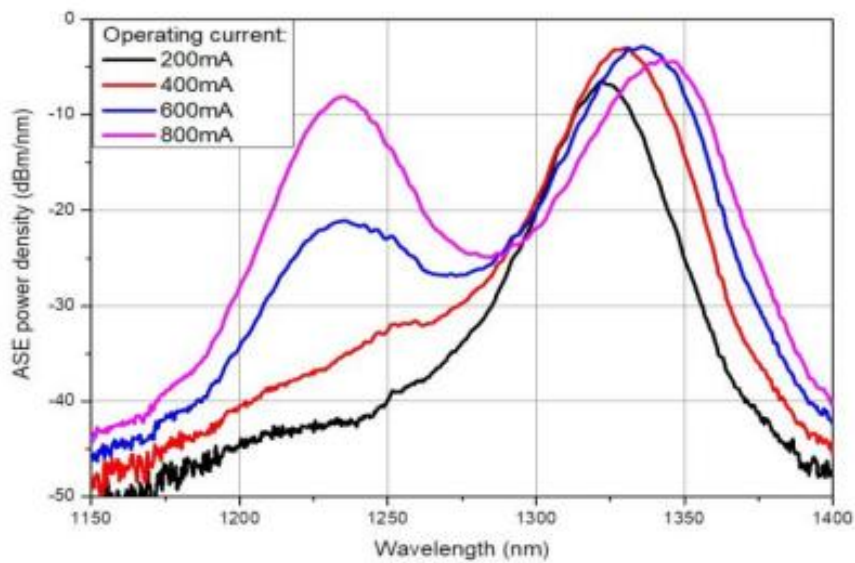

Operating Instructions

Safety and Operating Instructions

The light emitted by this device is invisible and hazardous to human eyes. Avoid direct viewing of the fiber connector while the device is in operation. When operating with the connector uncovered, appropriate laser safety goggles must be worn.

Absolute maximum ratings shall only be applied to the device for a short duration. Long-term exposure to maximum ratings or simultaneous exposure to multiple maximum ratings may cause device damage or reliability degradation. Operation beyond the device's maximum ratings may result in equipment failure and potential safety hazards. A dedicated matched power supply must be adopted to ensure the maximum forward current is not exceeded.

Devices mounted on heat spreaders require a qualified heat sink. The device shall be fixed to the heat sink with 4 screws (fastened in a cross pattern with an initial torque of 0.075 N · m and a final torque of 0.15 N · m) or clamps. The flatness deviation of the heat sink surface shall be less than 0.05 mm. Indium foil or flexible thermal interface materials are recommended between the device base and the heat sink. Thermal grease is not recommended for this application.

Prevent optical back-reflection, which may degrade the device's spectral performance and output power stability, and even cause catastrophic facet



damage. An optical isolator is strongly recommended to suppress back-reflection.

Do not pull the optical fiber. Avoid bending the fiber with a bending radius less than 3 cm. The fiber end-face shall be fully protected against contamination and mechanical damage during installation. After removing the dust cap, clean the fiber end-face unidirectionally with lens cleaning wipes or cotton swabs moistened with isopropyl alcohol or ethanol. Operate the device only with clean optical fiber connectors.

ESD Protection

Electrostatic discharge is a primary cause of unexpected product failure. Strict ESD precautions must be implemented at all times. Maintain continuous ESD protection during installation, including the use of anti-static wristbands, grounded work surfaces, and standardized anti-static operating procedures.

