

775nm 20mW SM Narrow Linewidth Laser

Diodes

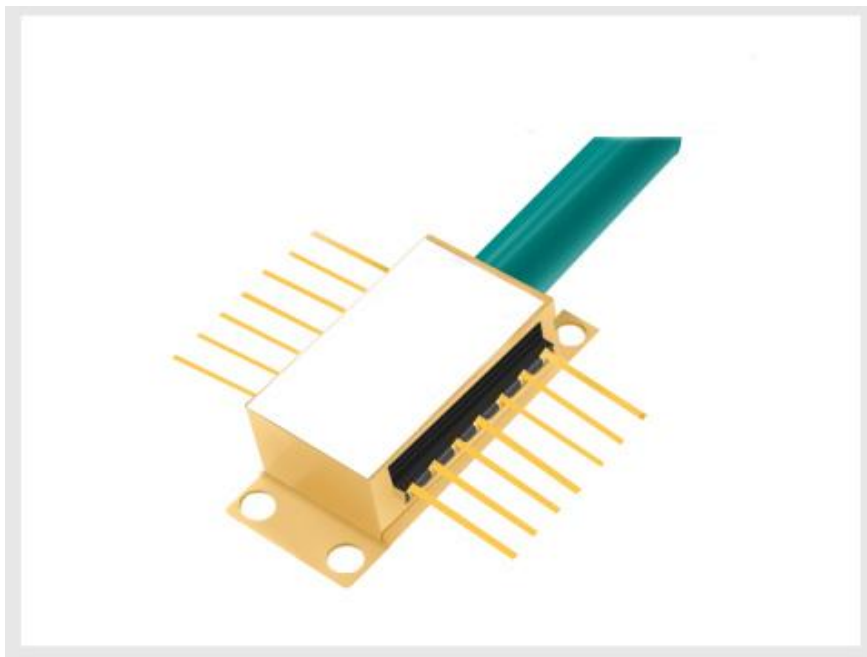

- **Product Description**

Single frequency FBG-stabilized laser diode module designed for optical measurement and communication. The laser is packaged in Butterfly package with monitor photodiode and thermo-electric cooler (TEC). Module is pigtailed with 0.5-0.9 m of single mode or polarization maintaining (optional) fiber and connectorized by FC/APC connector.



● Product features

Optical output: 20mW; Narrow linewidth ($\Delta\nu < 1\text{MHz}$); Wavelength: 770nm @ 25 °C ; SM or PM Fiber ($\varnothing 0.9\text{mm}$) ; FC-APC connector ; 14-pin butterfly package; Internal monitor PD and TEC; Low power consumption

● Part Number

MP-NL-775-A-A81-SA

● Application area

Coherent Optical Communication | High-Precision Fiber Optic Sensing | LiDAR | Optical Metrology & Spectroscopy | Microwave Photonics

● Core parameters

Wavelength	Output Power	Fiber Type
775nm	20mW	SM



● General Parameters

Optical and Electrical Characteristics

Parameter	Symbol	Test condition	Min.	Typ.	Max.	Unit
Optical Power	P_f	CW	10	20		mW
Pulsed Optical Power	P_{fp}	Pulse, $\tau=10\mu s$, D=1%		30		mW
Threshold Current	I_{th}		30	40	70	mA
Forward Current	I_f	P_f		100	150	mA
Pulsed Forward Current	I_{fp}	P_{fp} , $\tau=10\mu s$, D=1%		200		mA
Forward Voltage	V_f	P_f			2.5	V
Center Wavelength	λ_c	P_f	774	775	776	nm
Spectral Width	$\Delta\lambda_c$	P_f			1	MHz
Side Mode Suppression Ratio		SMSR	30			dB
Single-Frequency Continuous Tuning Range	Δf		1			GHz
Current Tuning	$\Delta\lambda/\Delta I$			0.001		nm/mA
Temperature Tuning	$\Delta\lambda/\Delta T$			0.08		nm/°C
Monitor Current	I_m	P_f	20		500	μA



PD Dark Current	I_d	$V_{rd}=5V$			0.1	μA
TEC Current	I_t	I_t			1.4	A
TEC Voltage	V_t	TC=70°C			2.7	V
Thermal Resistance	R_0	T=25°C, B=3900 $\pm 100K$	9.5	10	10.5	k Ω
Extinction Ratio (PM fiber)	X_p	P_f	20			dB

Absolute maximum ratings:

Parameter	Symbol	Rating	Unit
Forward Current	I_f	170	mA
Reverse Voltage	V_r	1.8	V
PD Reserve Voltage	V_{rd}	7	V
Minimum Operation Case Temperature	T_{ol}	-40	°C
Maximum Operation Case Temperature	T_{oh}	70	°C
Minimum Storage Temperature	T_{sl}	-40	°C
Maximum Storage Temperature	T_{sh}	70	°C
TEC Current	I_t	1.5	A

Pin definition

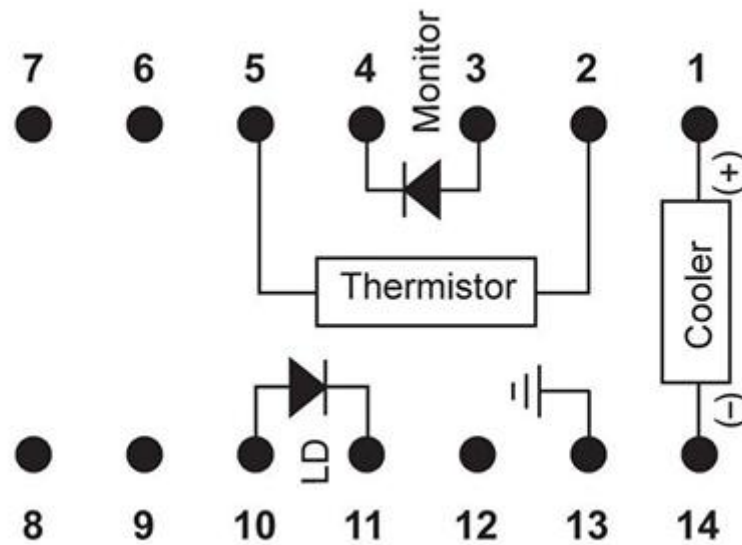

None PZT Built inside			
NO	Parameter	NO	Parameter
1	Cooler anode+	8	NC
2	Thermistor	9	NC
3	PD anode-	10	LD anode+
4	PD cathode+	11	LD cathode-
5	Thermistor	12	NC
6	NC	13	Case
7	NC	14	Cooler cathode-

L-I-V Curve

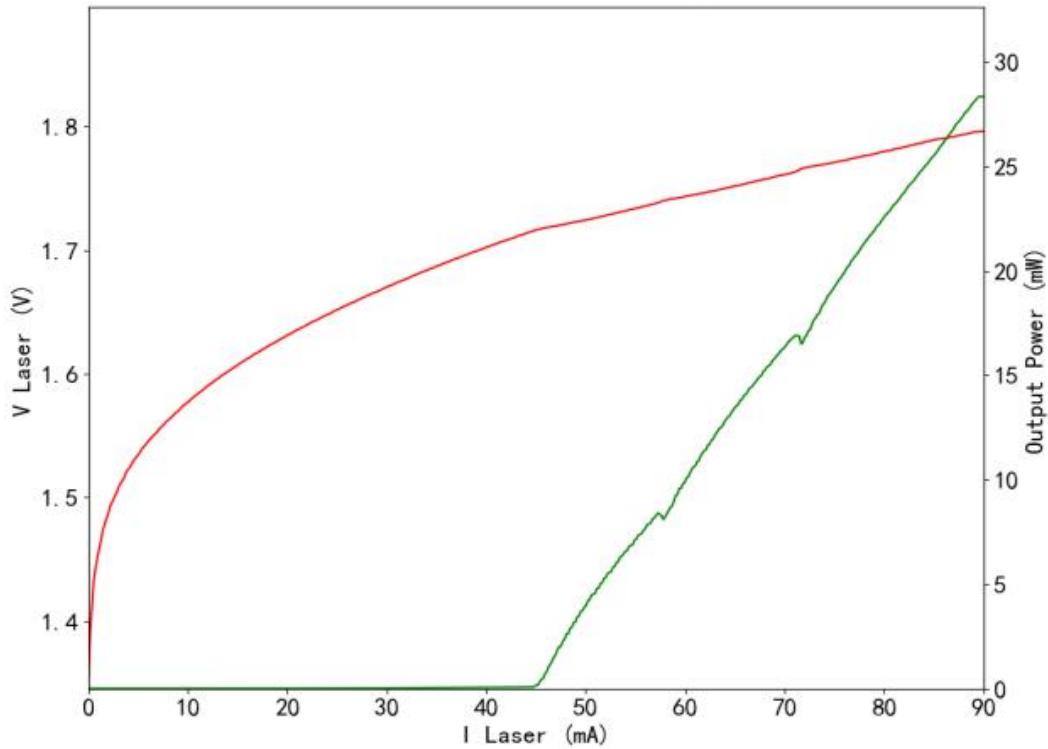

Wavelength Stability Measurement

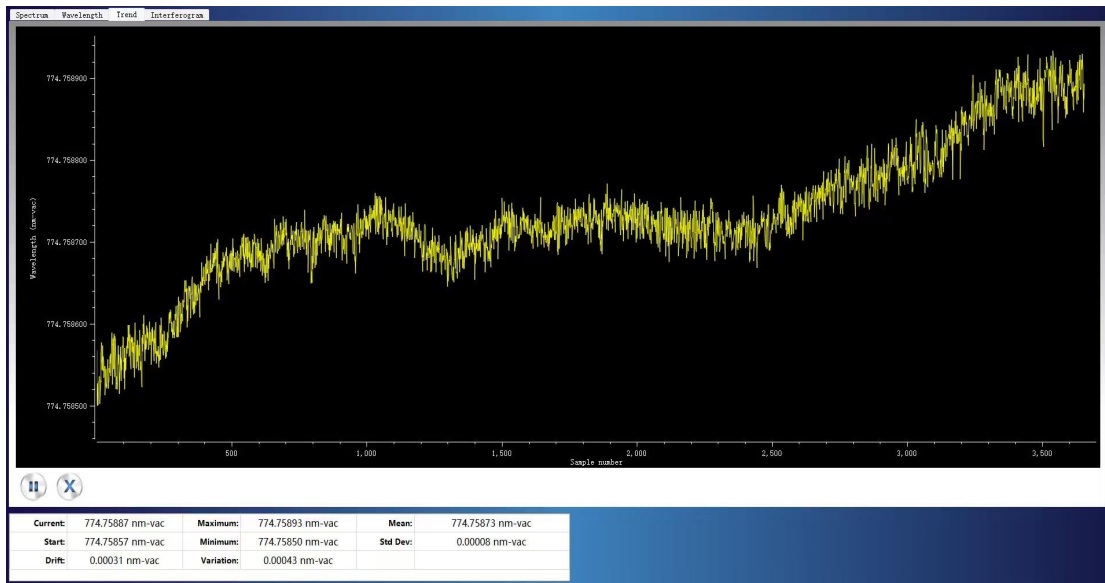



Beam Quality(M2,2D/3D Beam)

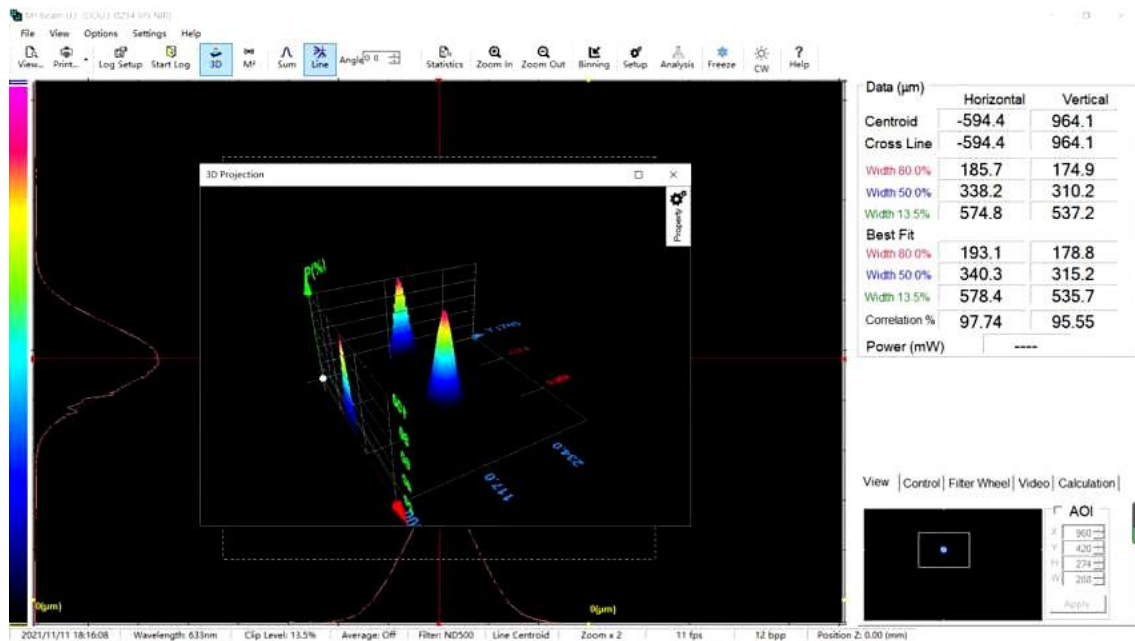

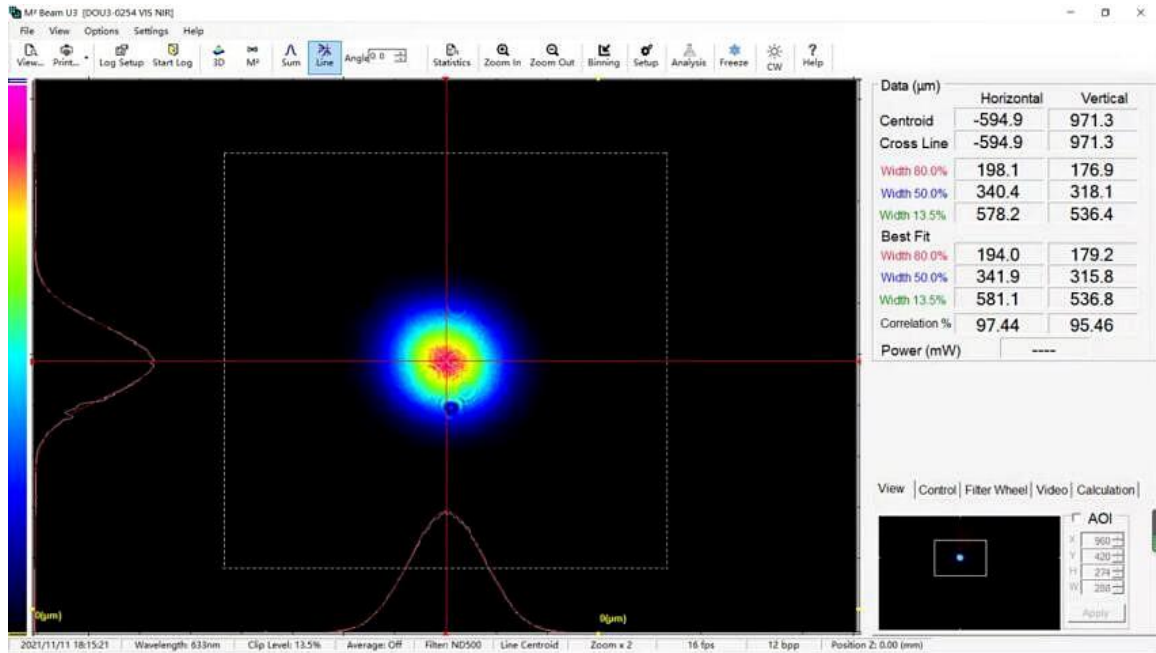

Fiber Pigtail Specifications

Parameters	Description
Fiber Type	HI780/PM780fiber
Jacket Type	900μm loose tube
Pigtail Length	1.0±0.1m
Connector Type	FC/APC
PM fiber Connector Orientation	Please see the right figure

Polarized light aligned
to the slow axis

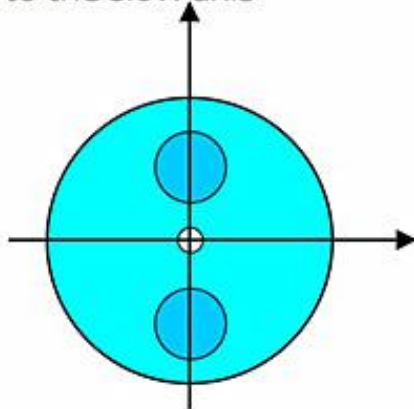

Polarized light aligned
to the fast axis

Note: The PM fiber and the connector key are aligned to the slow axis, fast axis is blocked